



# USER MANUAL



No Climb Products Ltd.  
163 Dixons Hill Road, Welham  
Green, Hertfordshire, AL9 7JE,  
United Kingdom  
Tel +44 (0)1707 282 760

EU: shift-consult Hubert Scherzinger  
Hessenweier 9,79108 Freiburg, DE  
Tel: +49 (0) 7665 91 21 74

[detectortesters.com](http://detectortesters.com)

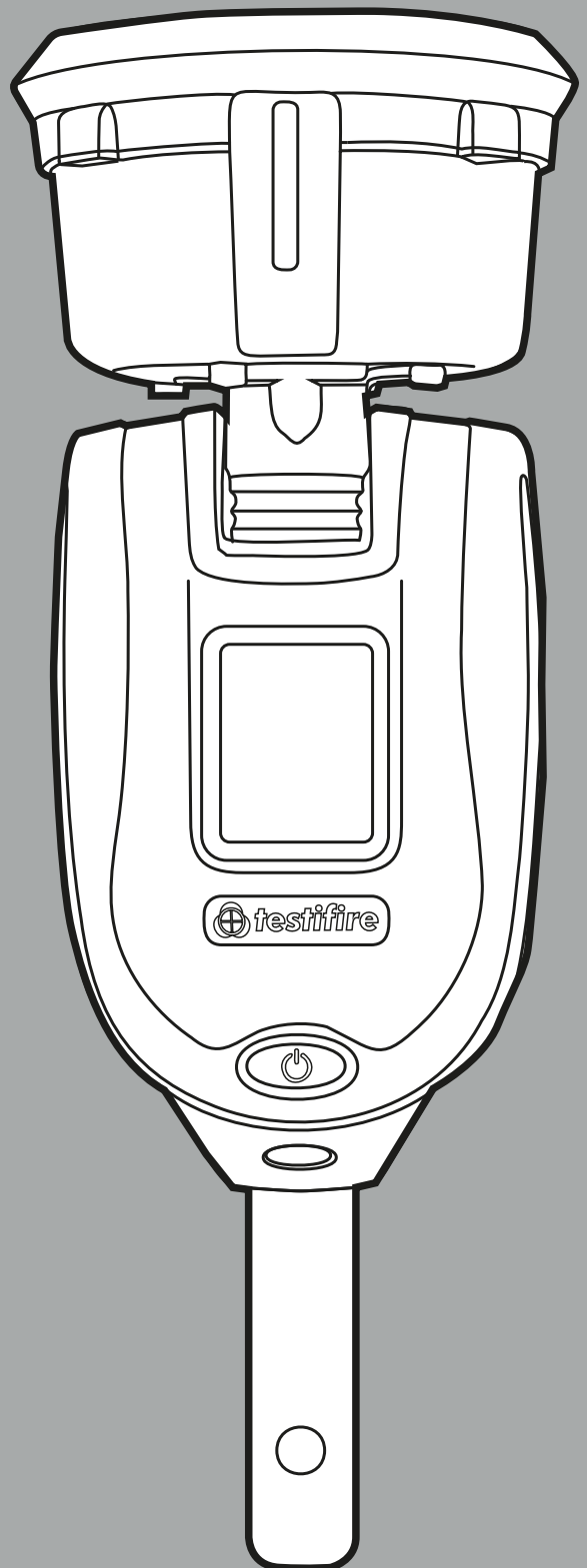

UK  
CA



# CAUTIONS & WARNINGS

## Warning

This product is intended to be used at height.

Exercise great care and always wear appropriate PPE (personal protective equipment) when operating above head height in order to avoid the risk of injury.

**DO NOT OVER REACH.** Keep proper footing and balance at all times. Proper footing and balance enables better control of the equipment in unexpected situations.

Pay particular attention to avoid contact with overhead items such as light fittings, overhead power cables and any other objects that could be accidentally dislodged which might cause danger to the operator or anyone else in the vicinity.

Avoid prolonged, direct exposure to the vapour generated by Testifire XTR2. Safety Data Sheets for the Testifire XTR2 battery pack and Testifire XTR2 Smoke Cartridge are available. It is recommended to review the safety data sheets for Testifire XTR2 Battery Pack and Testifire XTR2 Smoke Cartridge before use (see [detectortesters.com](http://detectortesters.com)).

This product contains hot parts.

**DO NOT TOUCH** the heat element. It may be very hot immediately after use and may burn if touched.

Contains precision parts which may be easily damaged and cause injury. **DO NOT TOUCH** the smoke fluid intake pipe in the smoke cartridge area or the heat element in the tester cup.

## Caution

Contains Lithium Ion rechargeable batteries:

- Do not dismantle, open, shred or incinerate batteries.
- Do not expose batteries to heat or fire. Avoid storage in direct sunlight.
- Do not short-circuit a battery. Do not store batteries loose in a box or drawer where they may short-circuit each other or be short-circuited by other metal objects.
- Do not subject batteries to mechanical shock.
- Keep batteries clean and dry.
- Do not use any charger other than that specifically provided for use with the equipment. Refer to the manufacturer's instructions or equipment manual for proper charging instructions.
- Do not leave a battery on prolonged charge when not in use.
- Do not use any battery which is not designed for use with this equipment.
- Do not use the battery in any other application.
- Keep batteries out of the reach of children.
- Dispose of properly.

## THE FOLLOWING SYMBOLS ARE USED THROUGHOUT THIS USER MANUAL AND ON THE PRODUCT:



This symbol on the product indicates that there is a safety hazard or an operation requiring care to avoid damage to the product or environment. You must read the appropriate sections of the User Manual to understand the nature and severity of all the potential hazards present and the action you must take.



This symbol on the product warns you of hot surfaces or heat by convection.



This symbol on the product indicates that you should read and understand this User Manual before using this product.



This symbol on the product indicates that this part of the device is susceptible to static damage.



To comply with WEEE (Waste Electrical & Electronic Equipment) Regulations the crossed out refuse container symbol on this product or literature indicates that it should not be disposed with other business waste at the end of its working life. To help ensure that valuable resources are reused and recycled, and to prevent possible harm to the environment or human health from uncontrolled waste disposal, please separate this from any other types of waste.

# **IMPORTANT INFORMATION**

- Read this User Manual completely before using your Testifire XTR2
- Keep this User Manual - save all safety and operational instructions for future reference.
- Take note of the Warnings - Read carefully and follow all warning labels on the product and those described in this User Manual.
- Testifire XTR2 is electronic test equipment and care should be taken when handling and storing. Dropping the unit on to a hard surface could damage it. Please look after it, treat it with care for lasting use.
- This product is designed for indoor use only and should not be subject to harsh environments. It is not designed for use in hazardous areas (those containing explosive vapour or dust). Do not use the equipment in places where temperatures and/or humidity are high or go through rapid changes including:
  - Direct sunlight
  - Near heat sources (stoves, radiators, etc.)
  - Sandy or dusty environments
  - In the presence of strong magnetic fields
  - Places prone to strong vibration
  - Restrictions detailed in the Technical Information (see Section 12).
- Testifire XTR2 may be used in ceiling and floor voids but care must be taken to ensure that the unit and cup can pass through gaps in both directions.
- Stop using Testifire XTR2 immediately if you notice any damage or unusual odours, liquids or sounds coming from the unit. Turn the power off immediately and consult technical support and troubleshooting (see section 11).
- Use only approved accessories as described in this manual that are recommended by the manufacturer for your Testifire XTR2 (see section 7).

# **KIT CONTENTS WHAT'S IN THE BOX?**

- Testifire XTR2 x1
- Testifire smoke generator x1
- TES3 smoke cartridge x1
- Testifire battery pack x1
- Battery charge cradle x1
- Mains power supply x1
- Car power adaptor x1
- Charger lead (USB-C to USB-C) x1
- Quick start guide

# CONTENTS

	Cautions and warnings	2
	Important information	2
	Kit Contents – What’s in the box?	3
<b>1.</b>	<b>General Instructions</b>	<b>6</b>
1.1	Warranty	6
1.1	Acknowledgement	6
1.2	Recycling	6
1.3	Declarations & Certifications	6
1.4	Privacy Policy	6
<b>2.</b>	<b>Testifire XTR2 Introduction</b>	<b>7</b>
<b>3.</b>	<b>Preparation for first use</b>	<b>8</b>
3.1	Getting started with DT Connect	8
3.2	Charging the Battery	9
3.3	Installing the Generator	9
3.4	Inserting the smoke cartridge	10
3.5	Inserting the Battery	10
<b>4.</b>	<b>Using Testifire XTR2</b>	<b>11</b>
4.1	Attaching Testifire XTR2 to Solo Access Poles	11
4.2	Powering on Testifire XTR2	11
4.3	LED Indicator Reference Chart	12
4.4	Adjusting the Head Unit Angle	12
<b>5.</b>	<b>Performing a Test</b>	<b>13</b>
5.1	Default Smoke Test	13
5.2	Heat Test	14
5.3	Combined Test	15
5.4	Sequential Test	16
5.5	Clearing a Detector	17
5.6	Delayed Start	17
5.7	Using the LED Torch	17
5.8	Manual Purge	18
5.9	Device Settings	18
<b>6.</b>	<b>ASD Adaptor – Testing ASD Systems and Flat Detectors</b>	<b>19</b>
6.1	Testing an ASD System or Flat Detector	19
6.2	Installing the ASD Adaptor	19
6.3	Testing with the ASD Adaptor	19
<b>7.</b>	<b>Removing and Replacing Consumables</b>	<b>20</b>
7.1	Removing the Smoke Cartridge	20
7.2	Replacing the Smoke Cartridge	20
7.3	Removing the Smoke Generator	20
7.4	Replacing the Smoke Generator	21
7.5	Removing the Battery for Charging	21
7.6	Replacing the Battery	21
7.7	Removing and Replacing the Membrane	21
<b>8.</b>	<b>Detector testers Cloud Portal</b>	<b>22</b>
8.1	Registering a New Account	22
8.2	Verifying Your New Account	22
8.3	Registering and Purchasing a Subscription for Testifire XTR2	23
8.3.1	Registering Testifire XTR2	23
8.3.2	Purchasing a Subscription for Testifire XTR2	23
8.3.3	Cancelling a Subscription	24
8.4	Managing Test Reports	24
8.5	Managing Technicians	24
8.6	Settings Menu	25
8.6.1	Uploading a Company Logo	25
8.6.2	Company Details	25
8.6.3	Profile Details	26
8.6.4	Changing Password	26
<b>9.</b>	<b>DT Connect App</b>	<b>27</b>
9.1	Downloading the App	27
9.2	Signing In	27
9.3	Pairing your Testifire XTR2	29
9.4	Creating a New Test Job	30
9.5	Performing a Test	31

9.5.1	Aborted Tests	32
9.5.2	Changing Test Mode	33
9.5.3	Changing Alarm Signal Mode	34
9.5.4	Manual Clearing	34
9.5.5	Using the Delayed Start mode	35
9.6	Closing a Test Job	37
9.7	Sharing a Test Report	39
9.8	App Settings Menu	41
9.8.1	Edit Profile	41
9.8.2	My Companies	41
9.8.3	Change Email Address	41
9.8.4	Change Password	41
9.8.5	Error History	41
9.8.6	Push Notifications	41
9.8.7	Vibration/Sound	41
9.8.8	Help	41
9.8.9	Give Feedback	42
9.8.10	Terms & Conditions	42
9.8.11	Privacy Policy	42
9.8.12	Deactivate Account	42
<b>10.</b>	<b>Consumables and Accessories</b>	<b>43</b>
<b>11.</b>	<b>Troubleshooting</b>	<b>44</b>
11.1	Device Error Codes	45
<b>12.</b>	<b>Support &amp; Technical</b>	<b>46</b>
12.1	Maintenance	46
12.2	Technical Information	47
12.3	Support Contact	48
	EU Declaration of Conformity	49

# GENERAL INSTRUCTIONS

## 1.1 Warranty

In addition to any other express warranty given in writing by the Company in relation to the Goods, the Company warrants that the Goods supplied under these terms and conditions will be in accordance with the specification (if any) contained in the Purchase Order, and will be free from defects in workmanship and material for a period of 24 months (device and charger) from the date of delivery to the Buyer, or for a period of 24 months after the date of sale by the Buyer to the final customer, or for a period of 24 months from the date of first registration with DT Connect, whichever period is the shorter.

## 1.1 Acknowledgement

Testifire™ is a registered trademark of No Climb Products Ltd. All other brand names mentioned are trademarks or registered marks of their respective holders, and are hereby acknowledged.

©2023 No Climb Products Ltd.  
All Rights Reserved.

## 1.2 Recycling

The packaging can be easily separated into the following materials:

- Cardboard (outer box)
- Cardboard (inner buffers, boxes)
- Polyethylene
- Plastic

Please dispose in line with local environmental requirements.

### WEEE (Waste Electrical & Electronic Equipment) Regulations

Testifire XTR2, accessories and batteries are suitably marked to be recycled in accordance with your local environmental requirements. Alternatively, these items may be returned to the manufacturer via your reseller for disposal in compliance with WEEE (Waste Electrical & Electronic Equipment) Regulations.

## 1.3 Declarations & Certifications

This product and its associated components are fully compliant with the following:

- CE (including EMC, LVD and RoHS)
- UKCA
- 2014/53/EU – Radio Equipment Directive (RED); Articles 3.1, 3.2 and 3.3
- 2011/65/EU – Reduction of Hazardous Substances (RoHS)
- UN38.3 - UN Standard for Lithium battery shipping

Further details regarding declarations and certifications are available upon request. Please contact support@detectortesters.com for more information.

### **WARNING**

If the Testifire XTR2 is used in a manner not specified by the manufacturer, the protection provided by the unit may be impaired.

Thank you for selecting Detectortesters for your equipment needs.

Your Testifire XTR2 has been designed with functionality, reliability, and safety in mind. It is your responsibility to use this instrument in conformance with local electrical codes. It is very important that the user follows installation instructions exactly as written. Do not attempt operation without this information.

## 1.4 Privacy Policy

Testifire XTR2 and DT Connect are covered by the Detectortesters (No Climb Products) privacy policy. Full details of the policy can be found on the Detectortesters website.

<https://www.detectortesters.com/privacy-policy/>

# 2

## TESTIFIRE XTR2 INTRODUCTION

Thank you for purchasing the Testifire XTR2 multifunction Smoke-Heat Detector Tester.

This manual is designed to assist you to get the best and most efficient use of the Testifire XTR2 and provides all the information required to perform routine service and maintenance tasks with ease.

Testifire XTR2 includes advanced technology that simplifies functional testing of smoke, heat and multi-function detectors in the field.

Full functionality of Testifire XTR2 requires the use of the DT Connect app and Cloud Portal. Prior to first use, Testifire XTR2 must be registered and paired to the app in order to function.

### Design Features

1. Tester cup
2. Cup membrane
3. Standoff plate
4. Smoke outlet
5. Heater element
6. Proximity sensor
7. Optical LED reader
8. LED torch
9. Air inlet
10. Power button
11. LCD touch display
12. Status LED's
13. Locking button
14. Battery pack
15. Smoke cartridge
16. Smoke generator

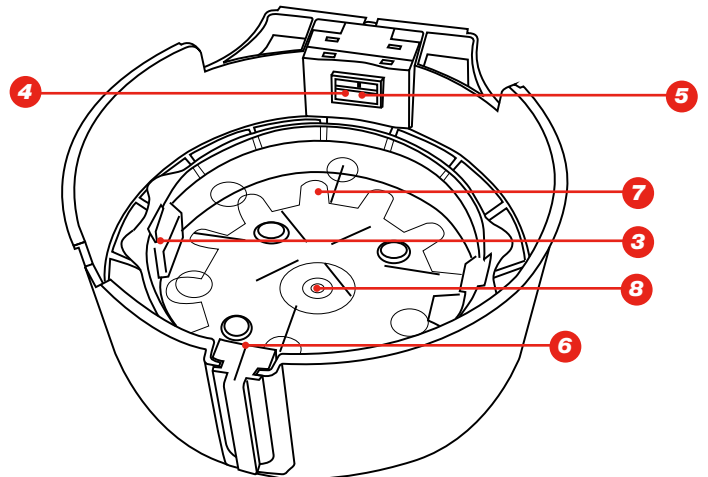
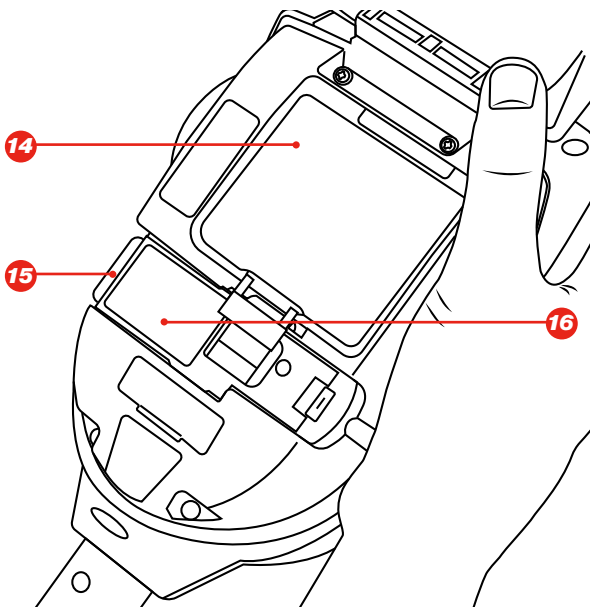
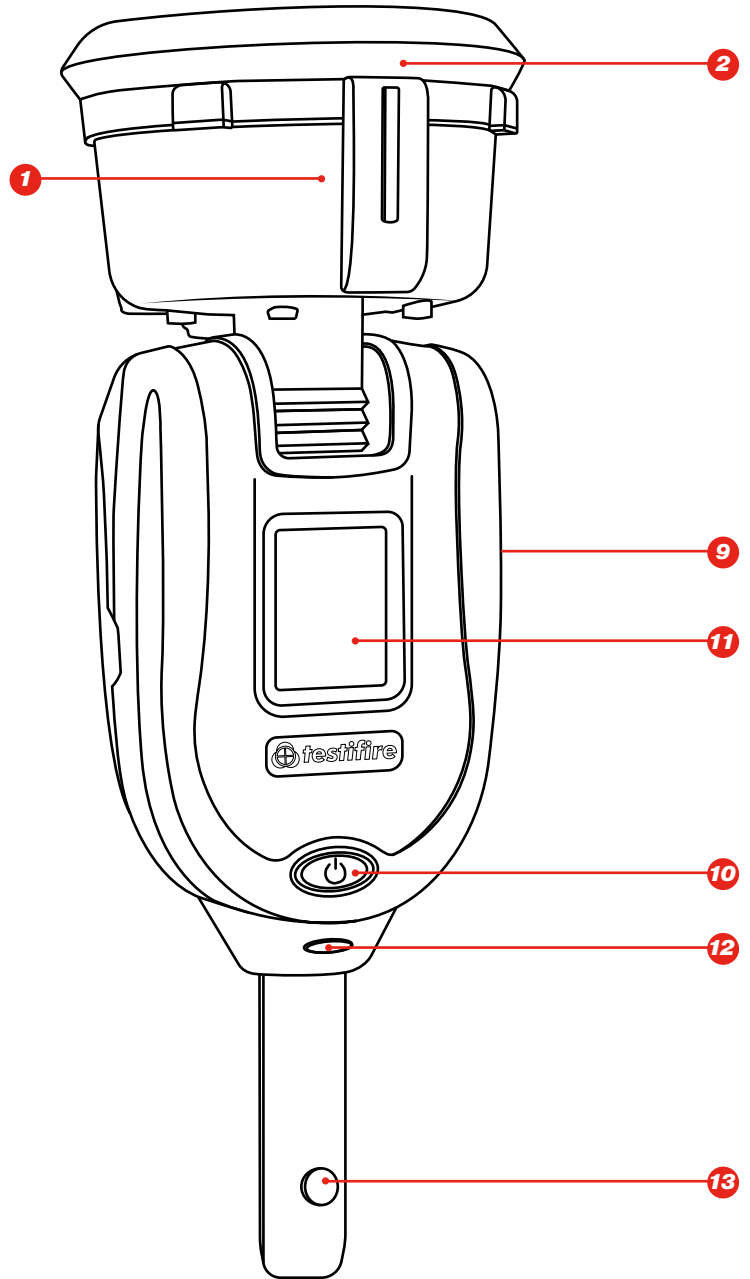

# 3 PREPARATION FOR FIRST USE

## 3.1 Getting started with DT Connect:

### STEP 1

Visit <https://detectortesters-connect.com> to create your account.

### STEP 2

Sign into the Cloud Portal to register your device. You will need to purchase a subscription to use connected services however your XTR2 comes with an extended free trial which starts from the moment you register your device. You will be informed via the portal and DT Connect app when your free trial subscription is about to expire.



### STEP 3

Download the DT Connect app for your smartphone device from the App Store or Google Play Store. The following smartphones are supported:

- Apple iPhone with iOS 12 or later
- Android OS 8 or later

## Get the DT Connect app



For help with DT Connect, including the app, Cloud Portal and subscriptions, scan the QR code:





### Prior to first use:

The battery is charged by fitting the battery pack into the charge cradle and connecting to a mains socket using the supplied power adaptor (Fig. 1)

### 3.2 Charging the Battery

- Ensure the battery is fully charged before use.
- Do not charge the battery outside of the specified operating temperature range (5-45°C).
- At low ambient temperatures (5-10°C), the battery may not charge completely but may continue to indicate that charging is in progress.
- If the battery pack detects that the temperature is outside of the operational temperature range for charging, a fault will be indicated by a red flashing LED.
- In the event of a battery charging fault, remove the battery from the charging cradle, ensure the battery is within the operational temperature range and retry charging the battery.

Figure 1

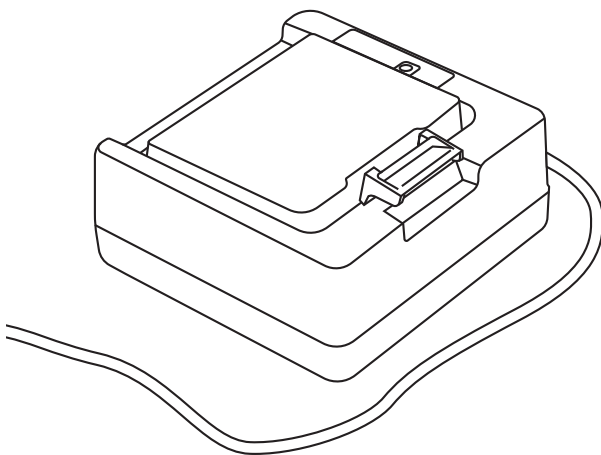

#### **WARNING**

Read cautions on lithium Ion rechargeable batteries before use (see page 2)

### 3.3 Installing the Generator

- Open the back cover
- Remove protective packaging of generator. Do not touch exposed electrical contacts.
- Insert generator firmly into recess, engaging clips 1 and 2 (see Fig.2)
- Once the generator is inserted, do not remove it until indicated that a replacement is necessary.
- When replacing a generator, any dust or debris within the Testifire XTR2 housing can be removed using an air duster. Any condensation can be removed by wiping with a lint-free cloth.
- Empty generators may be returned to the manufacturer via the reseller for environmentally friendly disposal to comply with WEEE (Waste Electrical & Electronic Equipment) Regulations.

Figure 2

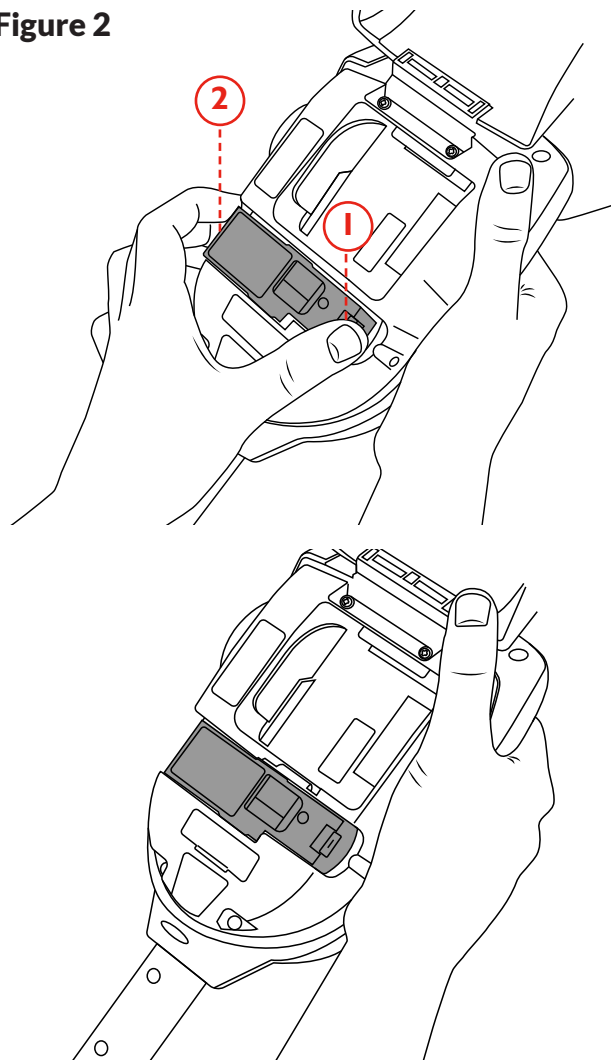

### 3.4 Inserting the smoke cartridge

- Remove the cartridge from bag.
- Do not insert the cartridge until the generator has been fully fitted to the main unit. See installing the Generator section 3.2.
- Slide cartridge completely into the generator housing following the guide rails (see Fig. 3)
- Once the cartridge is inserted do not remove it until indicated that a replacement is necessary. Do not re-use old cartridges.
- Empty cartridges may be returned to the manufacturer via the reseller for environmentally friendly disposal to comply with WEEE (Waste Electrical & Electronic Equipment) Regulations.

 **WARNING**

Do not touch the contacts on the PCB on the cartridge. Static electricity may cause damage and contamination of the contacts must be avoided.

Figure 3

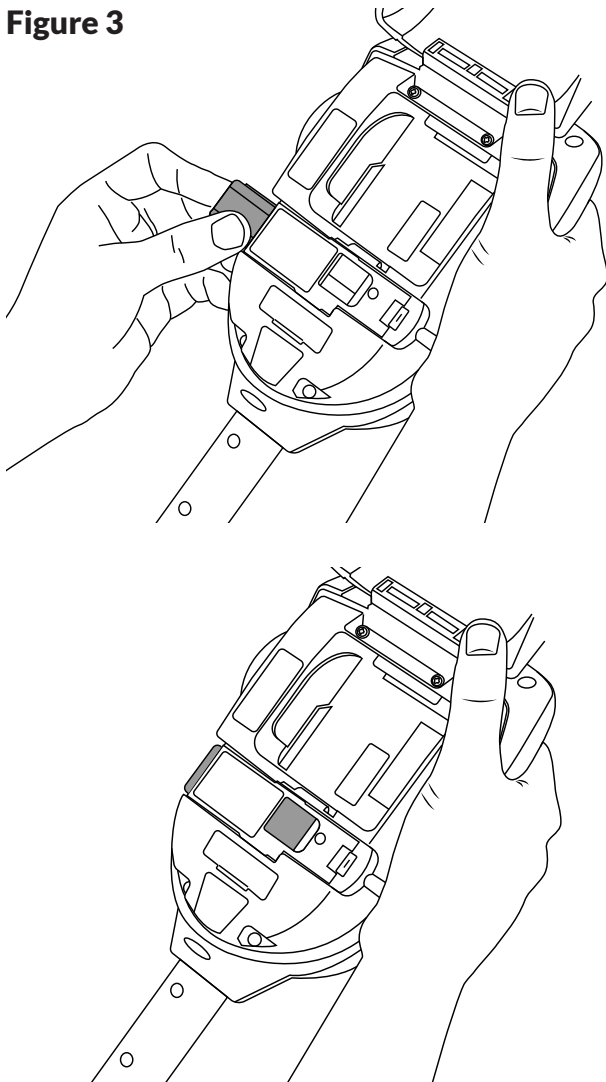

### 3.5 Inserting the Battery

- Once the battery is charged clip the battery pack into the battery compartment (Fig. 4).
- Do not force the battery into place
- Do not install the battery before the Smoke Generator and Smoke Cartridge
- Close the back cover before powering on

 **WARNING**

Do not touch the contacts on the battery. Static electricity may cause damage and contamination of the contacts must be avoided.

Figure 4

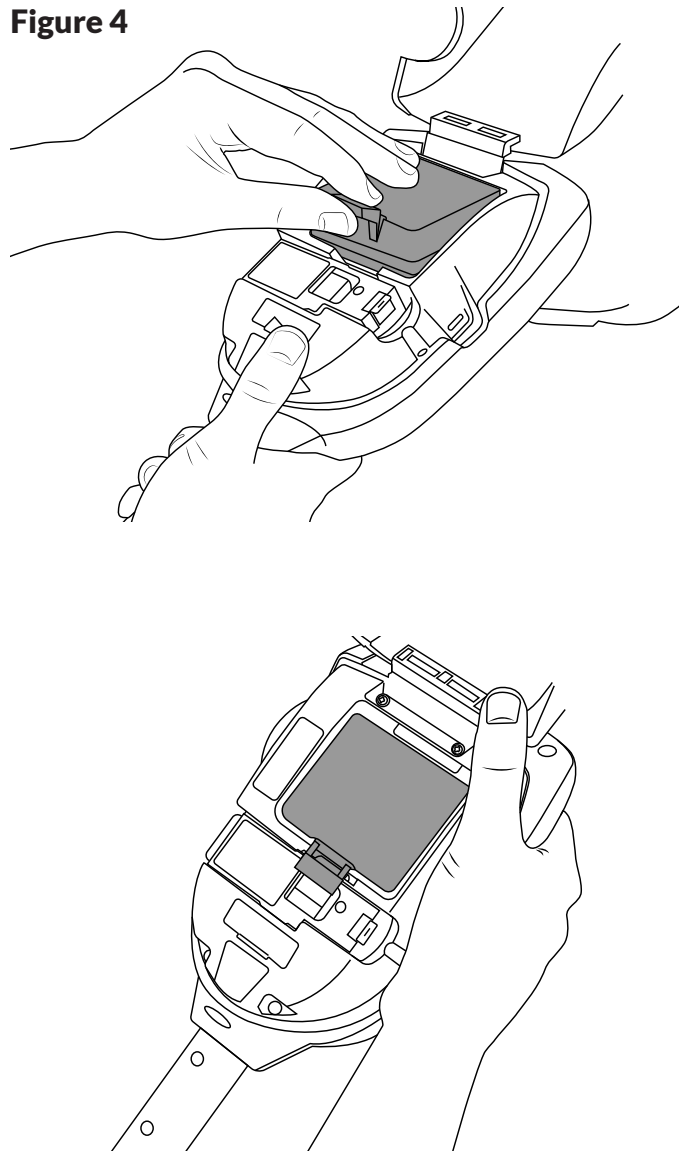

# 4

## USING TESTIFIRE XTR2

### 4.1 Attaching Testifire XTR2 to Solo Access Poles

Testifire XTR2 is designed for use with the Solo range of access poles (purchased separately). The product is not compatible with alternative poles.

Take the Solo access pole and press down the locking button on Testifire XTR2. Align it with the location hole and push the Testifire XTR2 handle further into the pole until the button springs up through the hole. Twist to lock (Fig. 5)

Figure 5

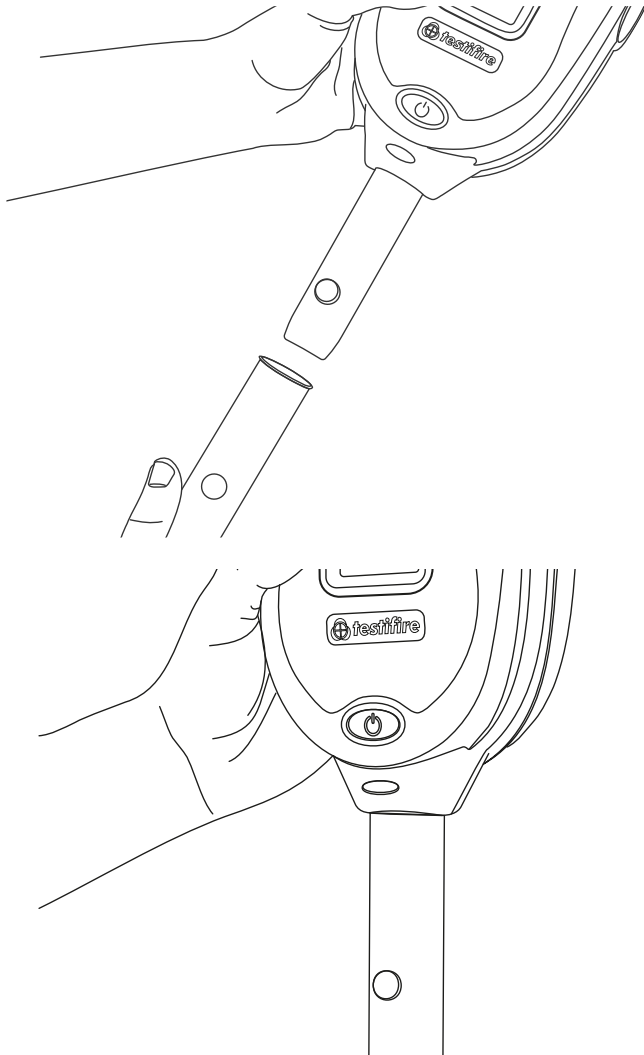

#### CAUTION

No more than three Solo extension poles should be used at the same time.

#### WARNING

When working at height it is recommended that a competent person carries out a suitable risk assessment. This will identify any risk to the user and/or the environment and hence any need for Personal Protective Equipment.

#### NOTE:

A Solo 101 extension pole can extend the Solo 100 and 108 telescopic poles, or may be used separately.

Similarly, a Solo 111 extension pole can extend the Solo 110.

For further information on the correct use of poles, see "instructions for Solo Poles" document in the support section of [detectortesters.com](https://www.detectortesters.com)

<https://www.detectortesters.com/manuals/>

### 4.2 Powering on Testifire XTR2

With the generator, cartridge and battery securely fitted and the back cover closed, the unit can now be powered on. Power the unit on by holding down the power button for 3 seconds.

#### NOTE:

After replacing a generator and powering on, a 'purge cycle' will run. During this the sound of the pump operating may be heard. This will last for approximately a few seconds after which, the unit will be ready for use. If no smoke is observed during a test a manual purge may be required (see section 5.8 for more detail on how to perform a manual purge).

The unit is functioning correctly if the status indicator LED's are solid blue and a Smoke test is selected on the LCD display (Fig. 6). If the status indicator LED's are not solid blue refer to the LED Reference Chart in section 4.3.

Figure 6

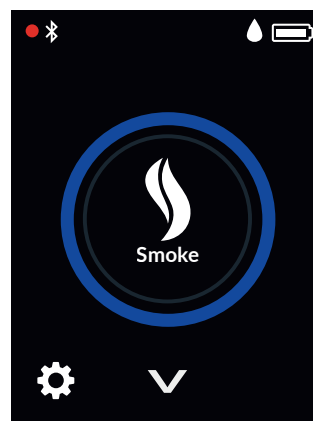

#### NOTE:

If Testifire XTR2 has been left unused for a period of time then a manual purge may be required.

### 4.3 LED Indicator Reference Chart







#### STATUS INDICATOR LEDS

Testifire XTR2 indicates events as follows:

##### WHEN IDLE

-  **SOLID BLUE**  
SMOKE TEST
-  **SOLID RED**  
HEAT TEST
-  **ALTERNATE SOLID RED/BLUE**  
COMBINED TEST
-  **SOLID ORANGE**  
DELAYED START
-  **SOLID WHITE**  
CLEARING
-  **SOLID PURPLE**  
SYSTEM FAULT

##### WHEN ACTIVE

-  **FLASHING BLUE**  
SMOKE TEST ACTIVE
-  **FLASHING RED**  
HEAT TEST ACTIVE
-  **FLASHING ALT RED/BLUE**  
COMBINED TEST ACTIVE
-  **FLASHING ORANGE**  
DELAYED START ACTIVE
-  **FLASHING WHITE**  
CLEARING ACTIVE
-  **TRIPLE FLASHING GREEN**  
PASSED TEST RESULT
-  **TRIPLE FLASHING RED**  
FAILED TEST RESULT

### 4.4 Adjusting the Head Unit Angle

Correct head angle adjustment is important to make sure that the detector to be tested is correctly positioned within the tester cup and that the user is in a safe and appropriate position to carry out the test.

The detector should touch the base of the Testifire XTR2 clear standoff and should be level with the base of the detector (Fig. 7)

Adjust the head unit for the correct angle to access the detector. Hold the body of Testifire XTR2 and gently move the cup forwards or backwards to the desired position.

Figure 7

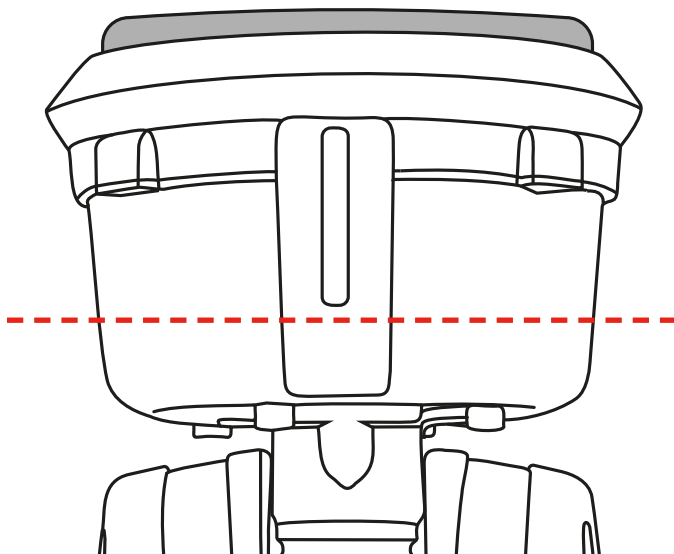

# 5

## PERFORMING A TEST

### 5.1 Default Smoke Test

After you have completed the preparation procedures your Testifire XTR2 will be ready for use.

When powered on, Testifire XTR2 LCD will be configured to perform a smoke test by default. The smoke icon will be visible on the LCD display and the status LED's will be solid blue (Fig. 8).

Figure 8

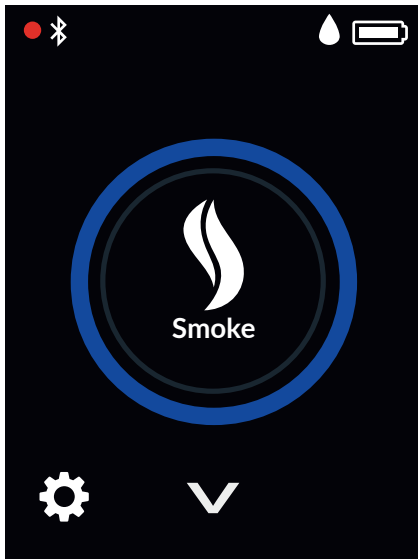

An infrared beam across the tester cup controls the test.

The test will begin automatically when the tester cup is placed over the detector, breaking the infrared beam.

The status LED will flash blue to indicate smoke is being generated and the test started (Fig. 9).

Figure 9

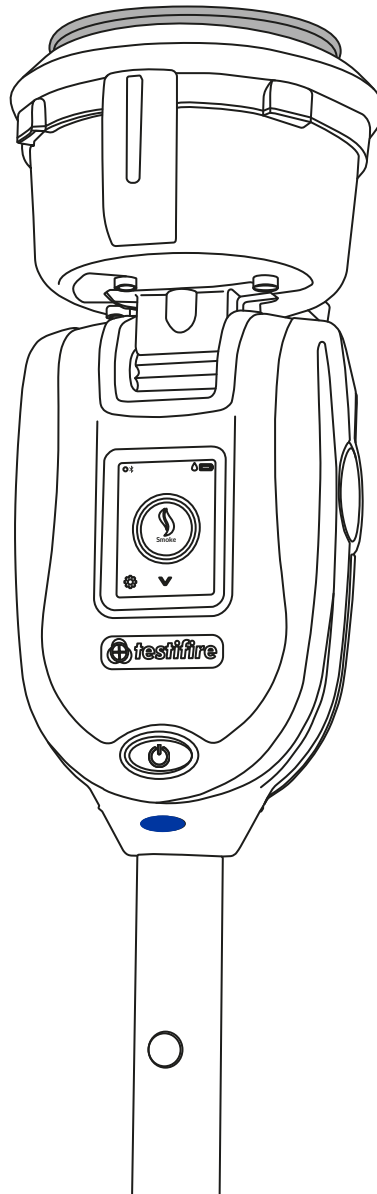

When the detector is activated, the optical LED reader inside the tester cup will sense the detector activation LED and automatically end the test.

The status LED's will flash triple green to indicate the test has been successful and clearing mode will begin automatically (see section 5.5). To end clearing, remove Testifire XTR2 by gently lowering it (Fig. 10).

Figure 10

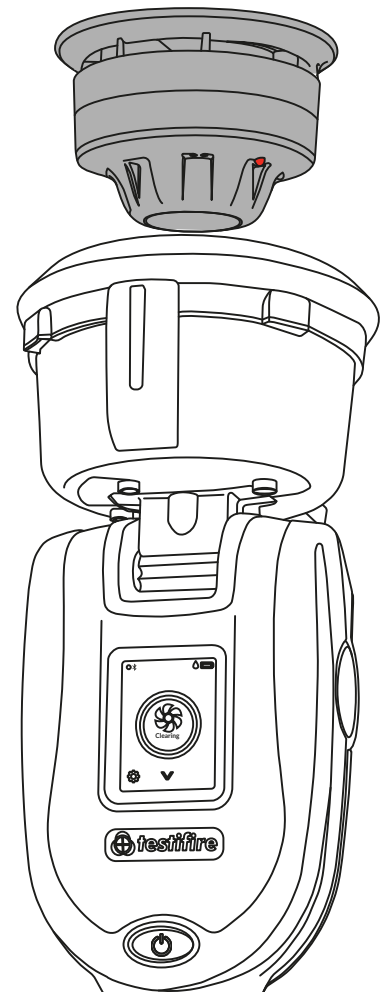

**NOTE:**

If after two minutes the test has not completed, Testifire XTR2 will time-out and the test will be recorded as failed. The status LED will flash triple red to indicate the test has been unsuccessful and you should remove Testifire XTR2 by gently lowering it.

## 5.2 Heat Test

Select the heat function using the navigation arrows on the LCD display. Once selected, the heat icon will be shown and the status LED will turn solid red.

Once the heat function is selected, tap the icon to select the high heat function. This will allow testing of high heat features. (Fig. 11)

**Figure 11**

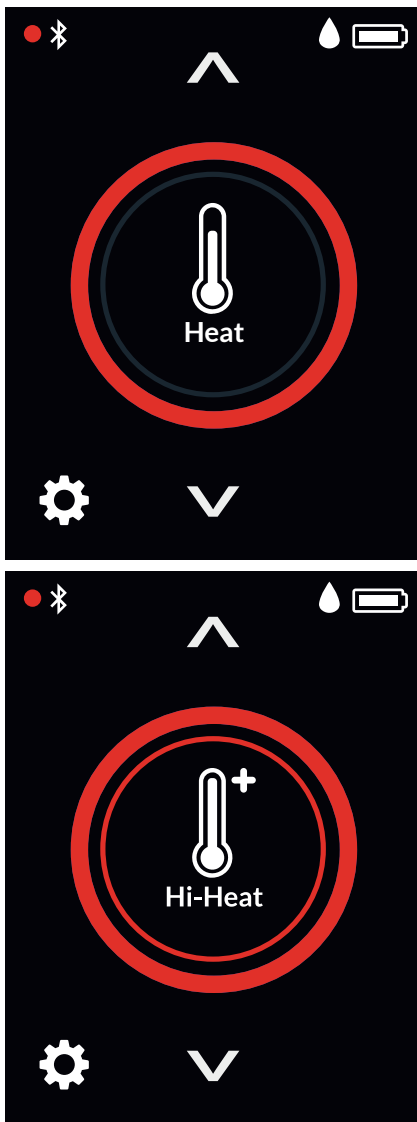

### CAUTION

Avoid placing hands near the duct outlet during heat testing or within 5 minutes of conducting heat testing. Hot air is emitted from the duct and the top of the duct will get hot to the touch.

An infrared beam across the tester cup controls the test.

The test will begin automatically when the tester cup is placed over the detector, breaking the infrared beam.

The status LED will flash red to indicate heat is being generated and the test started (Fig. 12).

#### TIP:

Rotating Testifire around the detector can speed up a test on detectors with offset thermistors

**Figure 12**

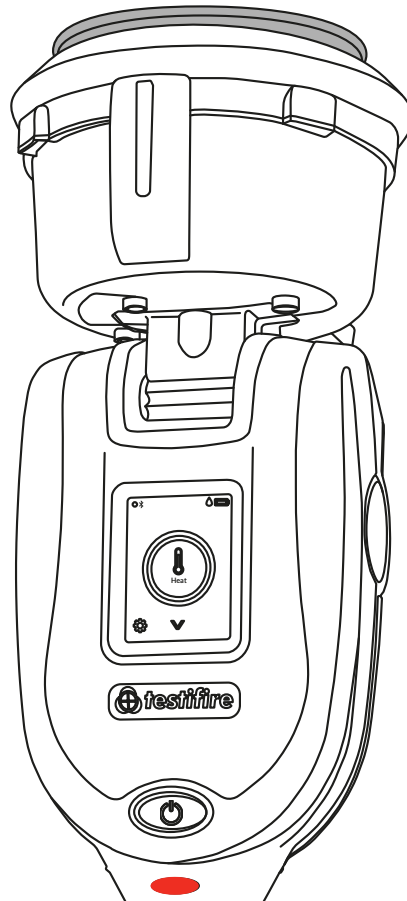

When the detector is activated, the optical LED reader inside the tester cup will sense the detector activation LED and automatically end the test.

The status LED will flash triple green to indicate the test has been successful and you should remove Testifire XTR2 by gently lowering it (Fig. 13).

**Figure 13**

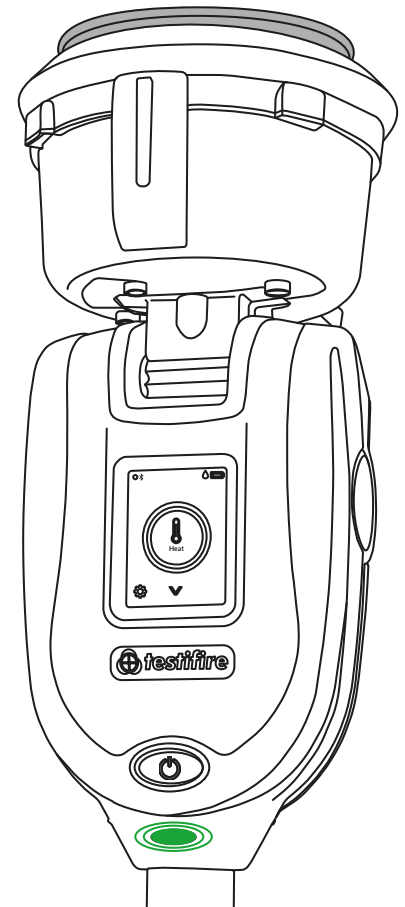

#### NOTE:

If after two minutes the test has not completed, Testifire XTR2 will time-out and the test will be recorded as failed. The status LED will flash triple red to indicate the test has been unsuccessful and you should remove Testifire XTR2 by gently lowering it.

### 5.3 Combined Test

Using Testifire XTR2 to carry out combined testing means that a number of operations (Smoke, Heat and Clearing) can be pre-programmed into the unit before it is raised up to the detector. This saves time, reduces handling and enables the testing of certain multi-sensor detectors.

Select the Combined function using the navigation arrows on the LCD display. Once selected the status LED's will alternate between solid blue and solid red (Fig. 14).

Figure 14

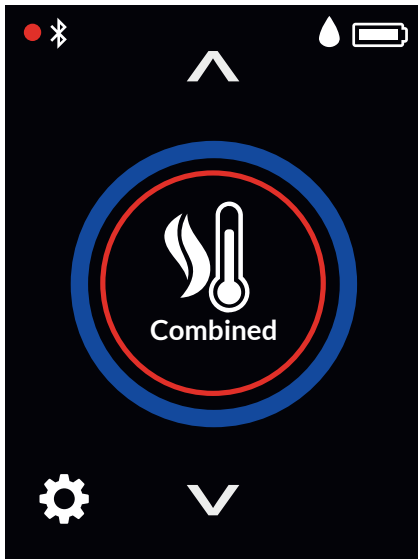

The test will begin automatically when the tester cup is placed over the detector, breaking the infrared beam.

When performing a combined test, the status LED will flash blue and red alternately to indicate both smoke and heat are being generated simultaneously (Fig. 15).

Figure 15

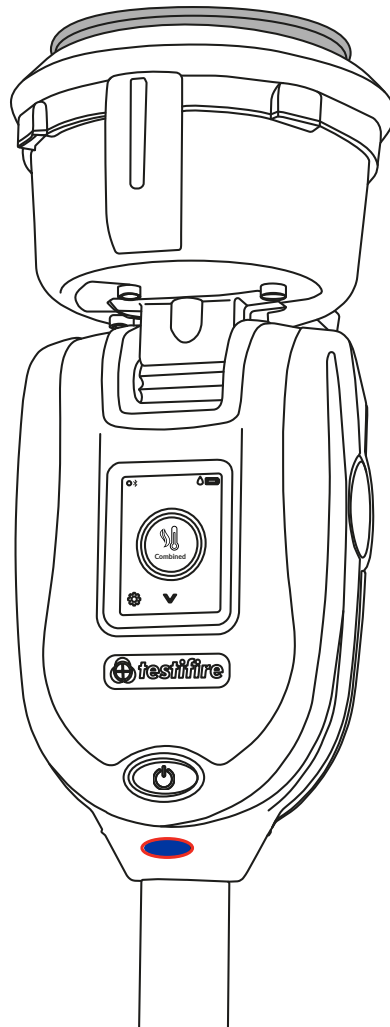

When the detector is activated, the optical LED reader inside the tester cup will sense the detector activation LED and automatically end the test.

The status LED's will flash triple green to indicate the test has been successful and clearing mode will begin automatically (see section 5.5). To end clearing, remove Testifire XTR2 by gently lowering it (Fig. 16).

Figure 16

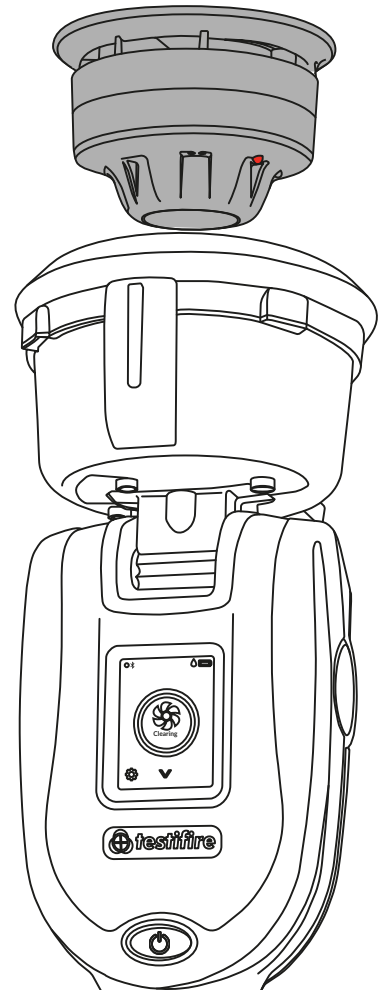

**NOTE:**

If after two minutes the test has not completed, Testifire XTR2 will time-out and the test will be recorded as failed. The status LED will flash triple red to indicate the test has been unsuccessful and you should remove Testifire XTR2 by gently lowering it.

## 5.4 Sequential Test

Using Testifire XTR2 to carry out a sequential test means that a number of operations (Smoke, Heat and Clearing) can be pre-programmed into the unit before it is raised up to the detector. This saves time, reduces handling and enables the testing of certain multi-sensor detectors.

Select the Sequential function using the navigation arrows on the LCD display (Fig. 17). Once selected the status LED's will turn solid red to identify the first test in the sequence as heat. Sequential tests follow the following predefined order:

1. Heat
2. Smoke
3. Clearing

**Figure 17**

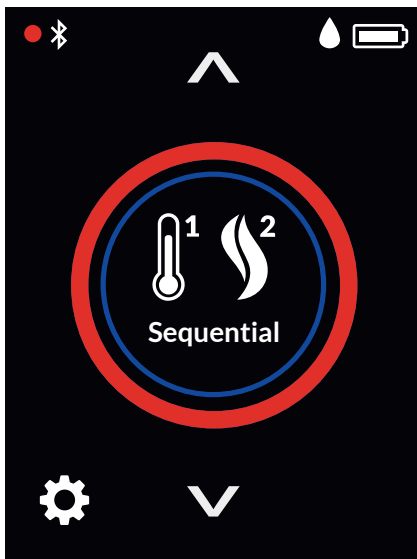

The test will begin automatically when the tester cup is placed over the detector, breaking the infrared beam.

When the detector is activated, the optical LED reader inside the tester cup will sense the detector activation LED and the next test mode will begin automatically (Fig. 18).

**Figure 18**

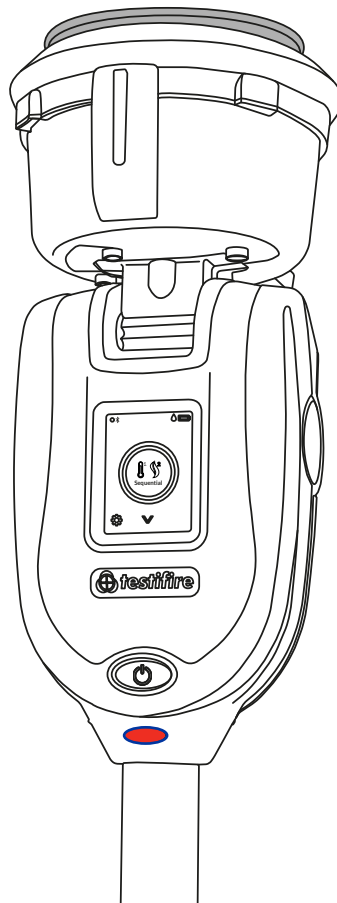

**NOTE:**

Lowering Testifire XTR2 from the detector during a sequential test will terminate the test.

Once the Sequential test is complete, the status LED's will flash triple green to indicate the test has been successful and clearing mode will begin automatically (see section 5.5).

To end clearing, remove Testifire XTR2 by gently lowering it (Fig. 19)

**Figure 19**

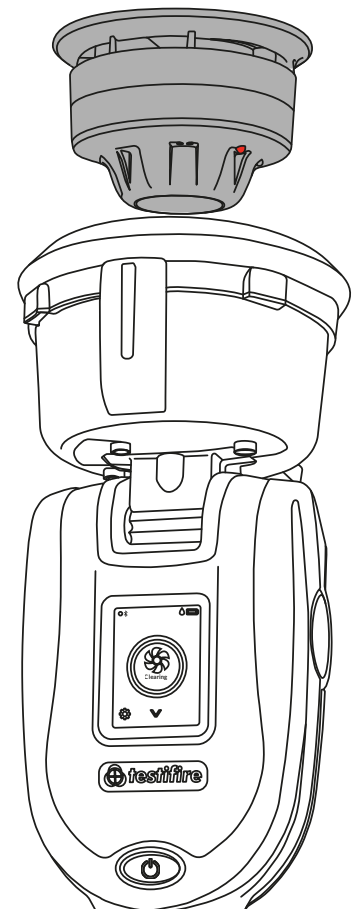

**NOTE:**

If after two minutes the test has not completed, Testifire XTR2 will time-out and the test will be recorded as failed. The status LED will flash triple red to indicate the test has been unsuccessful and you should remove Testifire XTR2 by gently lowering it.



## 5.5 Clearing a Detector

Once activated any lingering smoke can be cleared from the detector using the 'Clearing mode'. Air is blown around the detector – clearing any lingering smoke via the vent in the cup.

To perform clearing after a smoke, combined or sequential test, continue to hold Testifire XTR2 over the detector. If the test was successful, clearing will begin automatically and the status LED's will flash white (Fig. 20).

Figure 20



**NOTE:**

Automatic clearing does not occur following an unsuccessful test.

To perform clearing on its own, download the DT Connect app start a new Test Job:

1. Open the DT Connect app on your mobile device
2. Pair your Testifire XTR2 device and start a new test job
3. Select your test location and tap "next step"
4. Select the "Smoke" test mode and tap "Start Test".
5. Tap the "Clearing" icon in the top right hand corner

**NOTE:**

See section 8 for more information on using Testifire XTR2 with the DT Connect app.

## 5.6 Delayed Start

On occasions, it may be necessary to test detectors that do not easily fit into the Testifire XTR2 tester cup or are obstructed in some way. To allow testing of such detectors or aspirating smoke detection systems, Testifire XTR2 has the facility to delay the start of a test.

A separate adaptor (TESTIFIRE-ADAP-001) is required for ASD testing. Also see 6.1

To use this function, use the navigation arrows on the LCD menu until Delayed Start is displayed and tap the icon to begin the timer (Fig. 21).

Figure 21

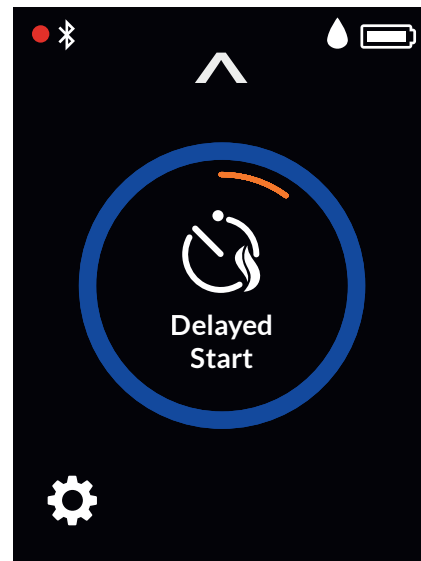

The default timer for the Delayed Start function is 20 seconds and can be adjusted using the DT Connect app.

1. Open the DT Connect app on your mobile device
2. Pair your Testifire XTR2 device and start a new test job
3. Select your test location and tap "next step"
4. Select the "ASD or Flat Detectors" test mode and tap "Start Test".
5. Choose from either 5, 20 or 40 seconds for the delayed start and tap "Start Test"

## 5.7 Using the LED Torch

In low light levels, an LED torch will automatically illuminate from inside the cup. This makes for easy alignment and testing of detectors in dark environments.

Upon alignment and the starting of the test the LED torch will switch off to allow a clear view of the status LED's and to enable the optical LED reader inside the tester cup.

## 5.8 Manual Purge

A manual purge may be required when the unit has not been used for a period of time, when in cold conditions, a new generator has been installed or in the case of a significant drop in performance. A manual purge should be carried out in a well ventilated.

Select the Settings icon from the bottom left corner of the LCD display and then select Purge. Tap the icon to begin the Purge function (Fig. 22).

**Figure 22**

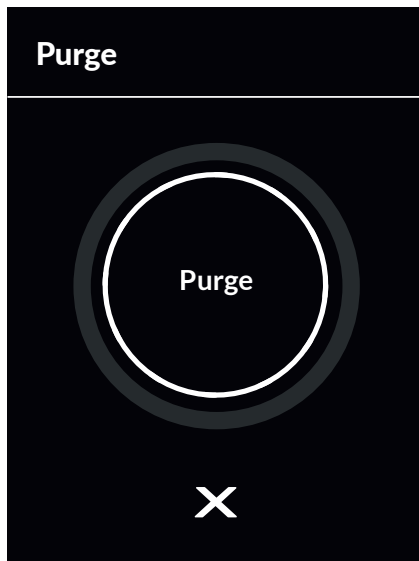

## 5.9 Device Settings

The device settings can be viewed by pressing the cog icon on your Testifire XTR2 display (Fig. 23). From this menu you can view the following settings:

1. Device information – including model, serial number, firmware version, battery serial number Bluetooth MAC address
2. Alarm detection mode – to choose if the optical LED reader responds to solid or flashing detector LED's, see section 9.5.2.1
3. Bluetooth settings – to access Bluetooth QR code for pairing with mobile devices
4. Purge – to perform a manual purge of the smoke generator (see section 5.8)

**Figure 23**

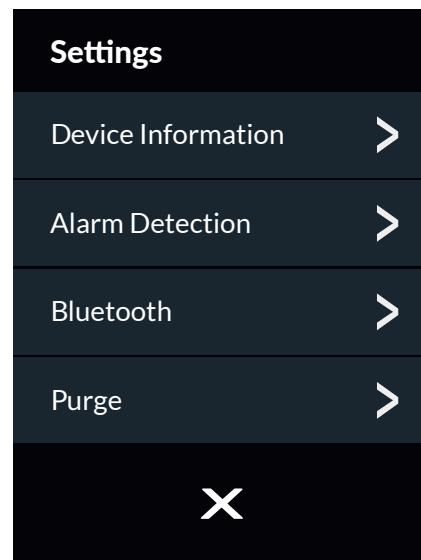

A manual purge can also be performed from the DT Connect app as follows:

1. Open the DT Connect app on your smartphone
2. Tap the Settings icon on the top left of the screen
3. Select "Help"
4. Tap "Purge"

### **NOTE:**

See section 8 for more information on using Testifire XTR2 with the DT Connect app.

# 6 ASD ADAPTOR – TESTING ASD SYSTEMS AND FLAT DETECTORS

## 6.1 Testing an ASD System or Flat Detectors

ASD systems and Flat Detectors can be tested using the Delayed Start mode and changing the tester membrane to the ASD Adaptor (Product Code: TESTIFIRE-ADAP-001).

2. The application has been thoroughly tested independently with all ASD technologies and a wide range of Flat Detectors.

## 6.2 Installing the ASD Adaptor

1. Ensure Testifire XTR2 is powered off
2. Remove the Testifire XTR2 membrane (see section 7.7)
3. Attach the ASD adaptor, stretching it over the tester cup and ensuring the tongues align with the relevant grooves in the tester cup (Fig. 24).

Figure 24

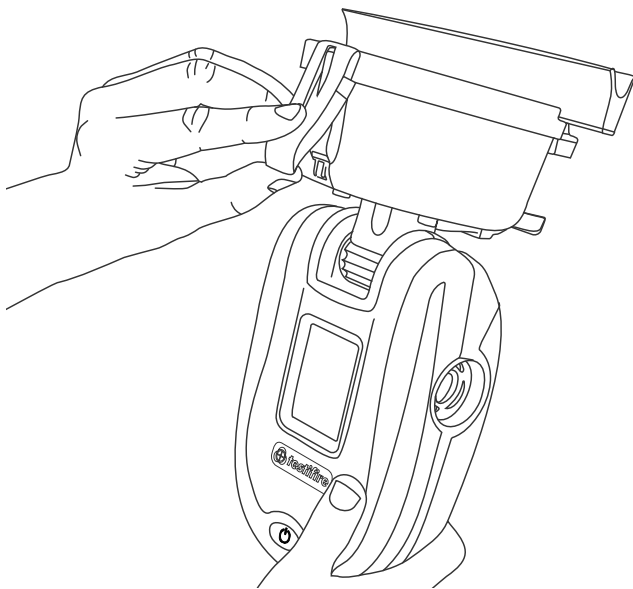

## 6.3 Testing with the ASD Adaptor

1. Power on Testifire XTR2
2. Select the Delayed Start mode by using the navigation arrows on the LCD display.
3. Tap the Delayed Start icon to begin the timer. During the timer the status LED's will flash orange
4. Locate Testifire XTR2 over the sampling hole. Smoke will automatically be generated for 20 seconds indicated by the status LED's flashing blue (Fig. 25).

Figure 25

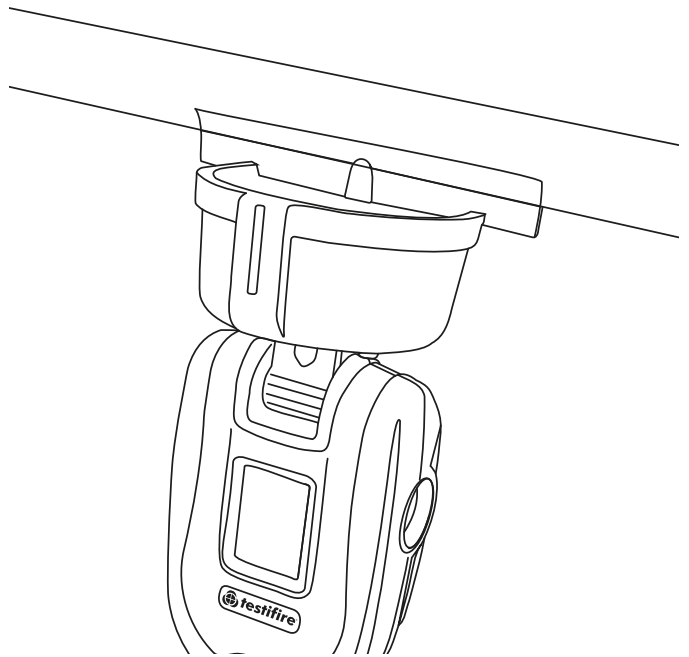

**NOTE:**

The delayed start timer is set to a 20 second by default and can be configured via the DT Connect App (see section 5.6).

# 7

## REMOVING AND REPLACING CONSUMABLES

All consumable parts of Testfire XTR2 can be replaced in the field without having to return the unit for service.

Ensure that the unit is switched off during the replacement of consumables. Do not touch electrical contacts.

### 7.1 Removing the Smoke Cartridge

1. Ensure the unit is switched off and open the back cover
2. Remove the smoke cartridge from the generator by placing your thumb in the recess and sliding the cartridge along the guide rails (Fig. 26). Do not remove the Generator

Figure 26

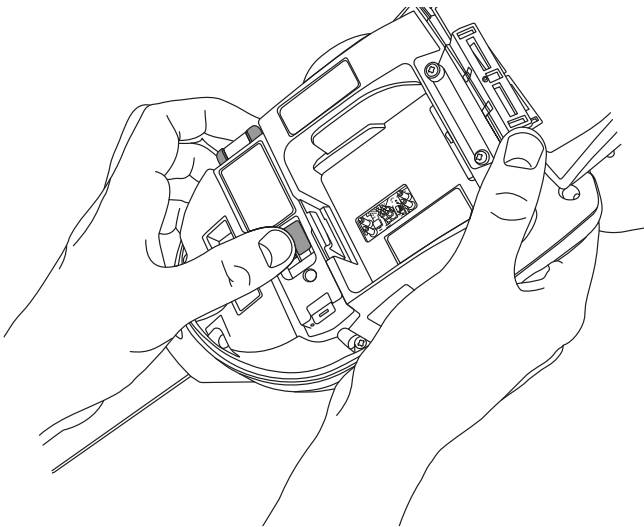

### 7.2 Replacing the Smoke Cartridge

1. Remove the Cartridge from the bag
2. Slide the cartridge completely into the generator housing following the guide rails (Fig. 27)
3. Once the cartridge is inserted into the generator do not remove it until indicated that a replacement is necessary on the LCD display or in the DT Connect app

Figure 27

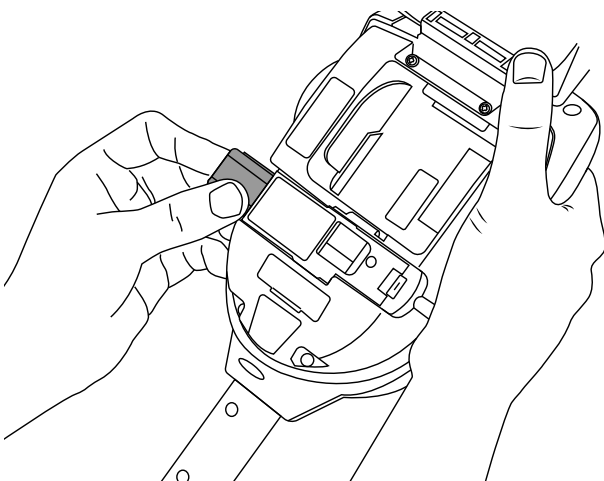

#### NOTE:

Do not re-use empty cartridges. Empty cartridges may be returned to the manufacturer via the reseller for environmentally friendly disposal to comply with WEEE (Waste Electrical & Electronic Equipment) Regulations.



#### WARNING

Do not touch the contacts on the cartridge. Static electricity may cause damage and contamination of the contacts must be avoided.

### 7.3 Removing the Smoke Generator

1. Ensure the unit is switched off and the Smoke Cartridge is removed (section 7.1)
2. Disengage Clip 1 and lift. Repeat for Clip 2 to remove the used generator (Fig. 28)

Figure 28

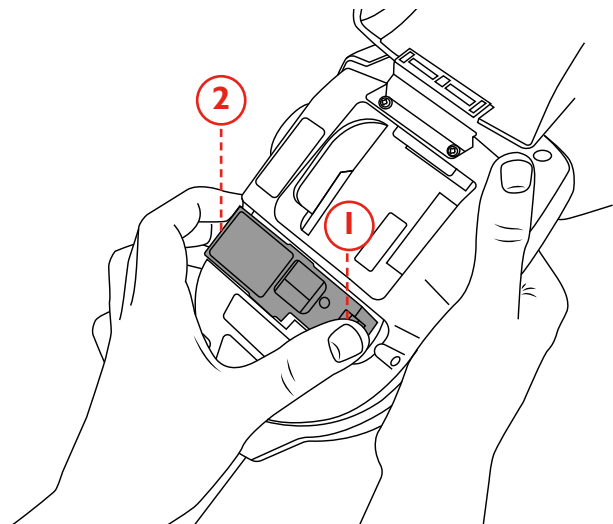

#### NOTE:

When replacing the generator, any dust or debris within the housing can be removed using an air duster. Condensation can be removed by wiping with a lint-free cloth.

## 7.4 Replacing the Smoke Generator

1. Insert the generator firmly into the recess, engaging clips 1 and 2 (Fig. 29)

Figure 29

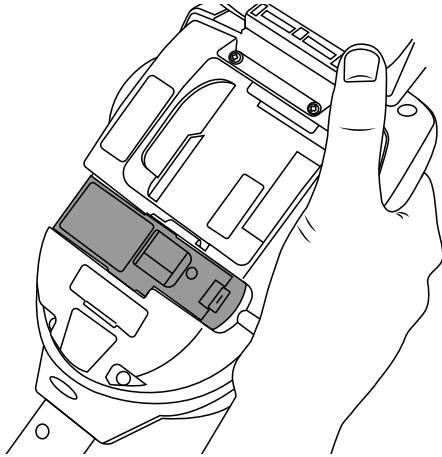

### NOTE:

Once the generator is inserted do not remove it until indicated that a replacement is necessary on the LCD display or in the DT Connect app.

### **WARNING**

Do not touch the contacts on the generator. Static electricity may cause damage and contamination of the contacts must be avoided.

## 7.5 Removing the Battery for Charging

1. Ensure the unit is switched off and open the back cover.
2. Unclip and remove the battery
3. Insert the battery into the charge cradle
4. Charge the battery by connecting the USB-C lead to the charge cradle and the supplied mains power adaptor or car adaptor (see Section 3.1)

### CHARGE CRADLE STATUS LED COLOUR



**FLASHING GREEN**  
BATTERY CHARGING



**SOLID GREEN**  
BATTERY FULLY CHARGED



**SOLID RED**  
NO BATTERY CONNECTED



**FLASHING RED**  
BATTERY FAULT

## 7.6 Replacing the Battery

1. Once the battery is charged gently clip it into the battery compartment and close the back cover (Fig. 30)

Figure 30

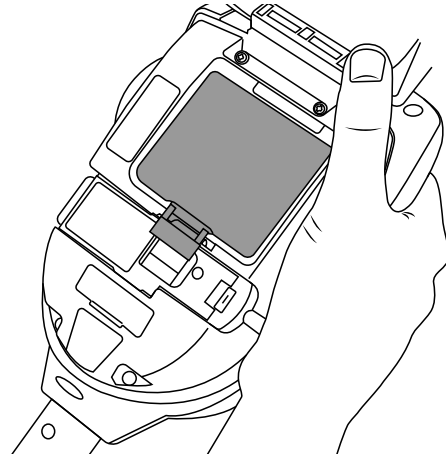

### NOTE:

Do not force the battery into place.



### **WARNING**

Do not touch the contacts on the battery or charge cradle. Static electricity may cause damage and contamination of the contacts must be avoided.

## 7.7 Removing and Replacing the Membrane

1. Ease the membrane off the tester cup carefully
2. Take the replacement membrane and stretch it over the tester cup. Ensure the membrane tongues align with the relevant grooves in the tester cup (fig. 31)

Figure 31

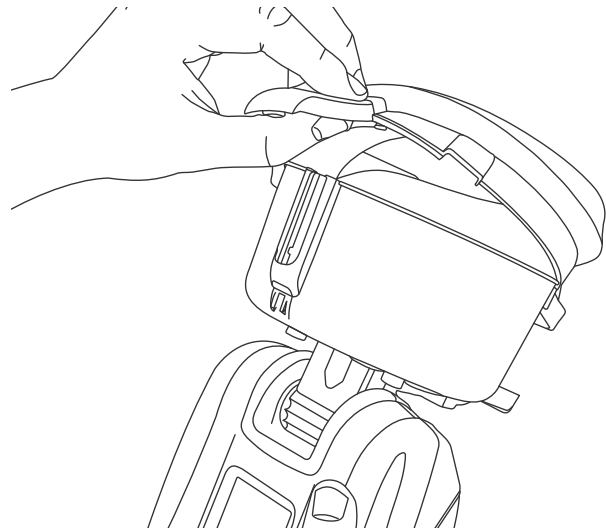

# 8 DETECTORTESTERS CLOUD PORTAL

The Cloud Portal provides access to digital test reports and enables management of technicians, devices, and active subscriptions in a convenient dashboard.

To register a new account or sign in, visit <https://detectortesters-connect.com>

Note that a valid email address is required to register with DT Connect.

## 8.1 Registering a New Account

Click “Create Account” to register a new account. (Fig. 32)

Figure 32

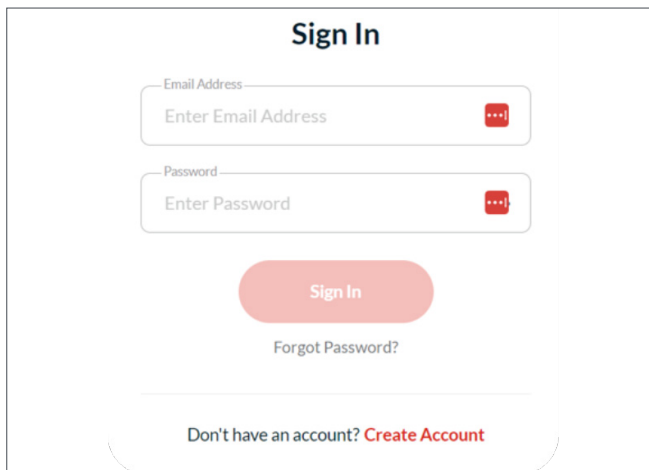

The Sign In form features a title "Sign In" at the top. Below it are two input fields: "Email Address" with the placeholder "Enter Email Address" and "Password" with the placeholder "Enter Password". Both fields have a red eye icon to toggle visibility. A red "Sign In" button is centered below the fields. Below the button is a link "Forgot Password?". At the bottom, there is a link "Don't have an account? Create Account".

Provide your name, email and password and click “Next” (Fig. 33)

Figure 33

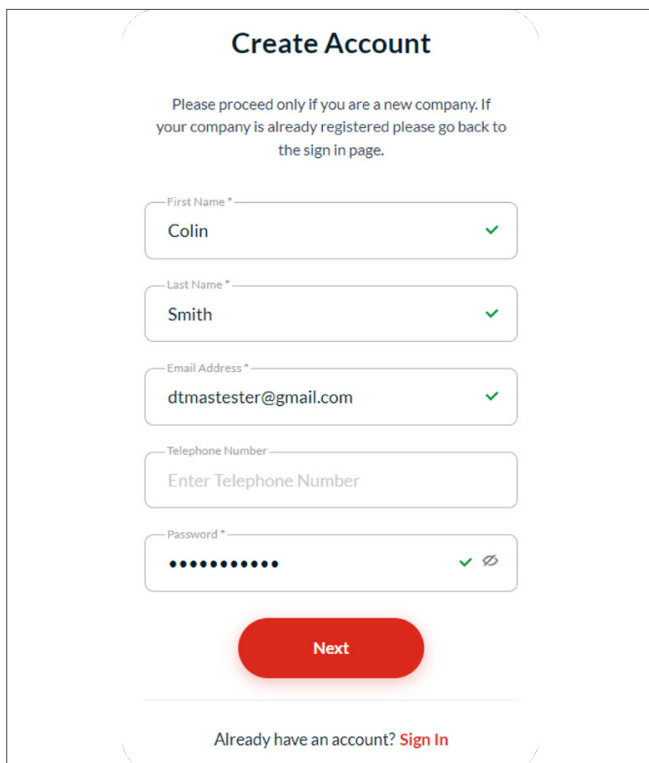

The Create Account form has a title "Create Account" and a message: "Please proceed only if you are a new company. If your company is already registered please go back to the sign in page." Below this are several input fields: "First Name" (Colin), "Last Name" (Smith), "Email Address" (dtmastester@gmail.com), "Telephone Number" (placeholder: Enter Telephone Number), and "Password" (masked with dots). Each field has a green checkmark. A red "Next" button is at the bottom. At the very bottom, there is a link "Already have an account? Sign In".

### NOTE:

For security, be sure to use an email address that only you can access.

Provide your company details to complete the registration process (Fig. 34)

Figure 34

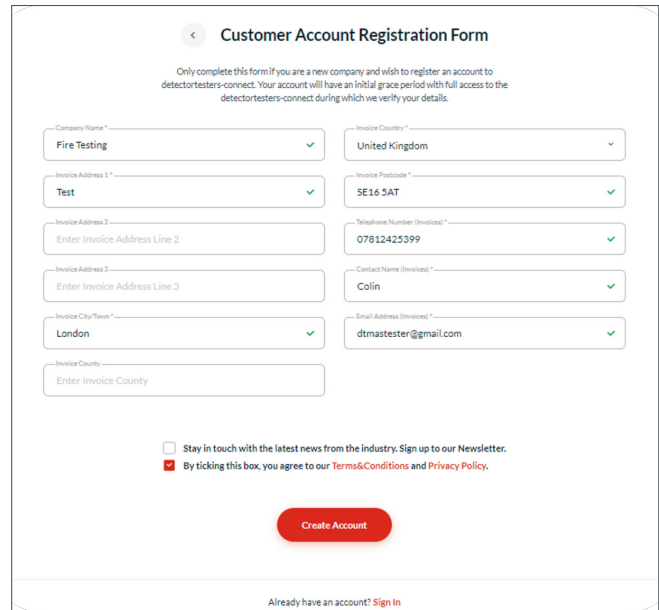

The Customer Account Registration Form is titled "Customer Account Registration Form". It includes a disclaimer: "Only complete this form if you are a new company and wish to register an account to detectortesters-connect. Your account will have an initial grace period with full access to the detectortesters-connect during which we verify your details." The form contains multiple input fields: "Company Name" (Fire Testing), "Invoice Country" (United Kingdom), "Invoice Address 1" (Test), "Invoice Postcode" (SE16 5AT), "Invoice Address 2" (placeholder: Enter Invoice Address Line 2), "Telephone Number (Invoices)" (07812425399), "Invoice Address 3" (placeholder: Enter Invoice Address Line 3), "Contact Name (Invoices)" (Colin), "Invoice City/Town" (London), "Email Address (Invoices)" (dtmastester@gmail.com), and "Invoice Country" (placeholder: Enter Invoice Country). There are checkboxes for "Stay in touch with the latest news from the industry. Sign up to our Newsletter." and "By ticking this box, you agree to our Terms&Conditions and Privacy Policy." A red "Create Account" button is at the bottom. At the very bottom, there is a link "Already have an account? Sign In".

### NOTE:

Only register your company once. If you have previously registered with DT Connect, sign in with your email and password or use the “Forgot Password?” option.

## 8.2 Verifying Your New Account

Once you have completed the registration process you will need to verify your account. A verification email will be sent to the email address provided during the registration process (Fig. 35). Click the link to confirm your account before signing into the cloud portal

Figure 35

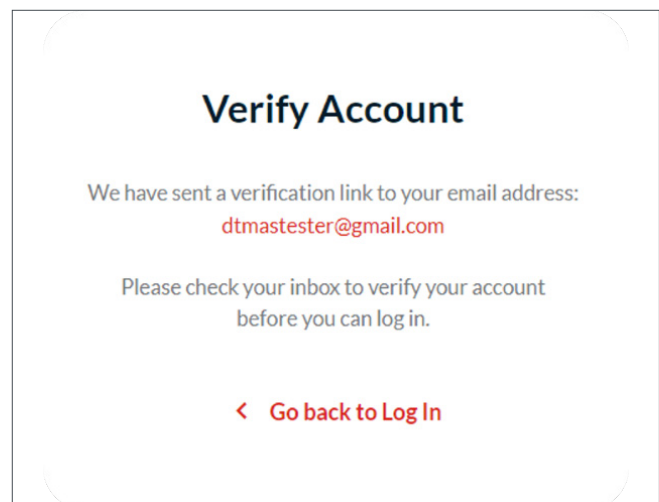

The Verify Account screen has a title "Verify Account". It displays a message: "We have sent a verification link to your email address: dtmastester@gmail.com". Below this is another message: "Please check your inbox to verify your account before you can log in." At the bottom, there is a red button with a left arrow and the text "Go back to Log In".

### 8.3 Managing Devices and Subscriptions

The Devices Dashboard provides a summary of all testers registered to your company, including:

- Active Subscription
- Serial number
- Product name (e.g. Testifire XTR2)
- Name of last user
- Date of last use
- Location of last use
- Date of registration
- Warranty end date

#### 8.3.1 Registering Testifire XTR2

To register a new device and purchase a subscription “Add New Device” and enter the device serial number (Fig. 36)

Figure 36

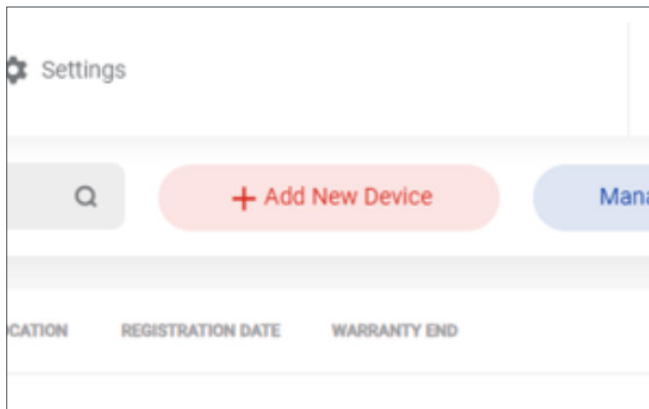

Enter your product serial number. Click “Add Device”. (Fig. 37)

Figure 37

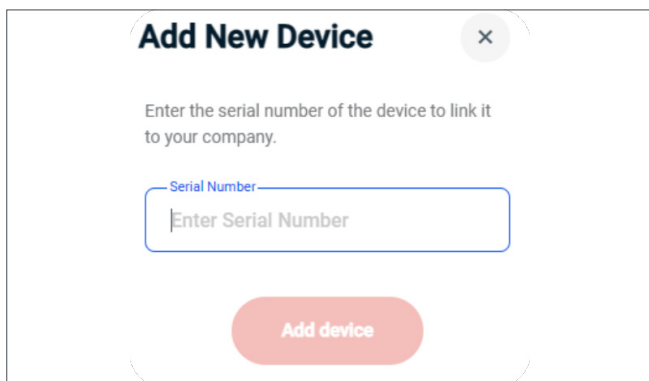

**NOTE:**

Your device serial number can be viewed in the Device Information screen in the settings menu on Testifire XTR2 (see section 5.9 Device Settings).

Testifire XTR2 must be registered in the Cloud Portal before it can be paired with the Detectortesters Connect app

#### 8.3.2 Purchasing a Subscription for Testifire XTR2

Once you register your new Testifire XTR2 you may purchase an optional subscription to enable premium features in the DT Connect app and Cloud Portal. To purchase a subscription, click “Subscribe” (Fig. 37)

Figure 37

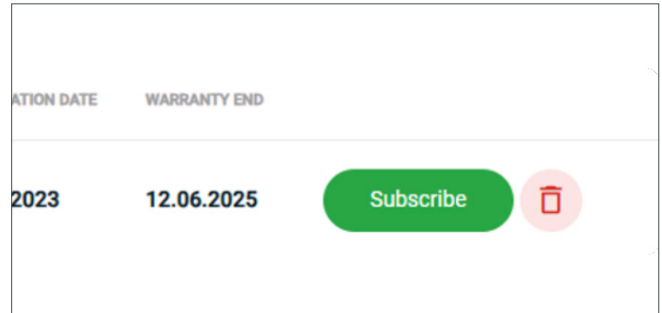

Purchase your subscription by entering your preferred payment card details at the checkout (Fig. 38)

Figure 38



**IMPORTANT:**

If you have recently created a new account, Detectortesters will need to verify and confirm the new company before subscriptions can be purchased in the cloud portal. This process should take approximately 24-48 hours and is confirmed when the “Pending” status is replaced by a green tick (Fig. 39.)

Figure 39

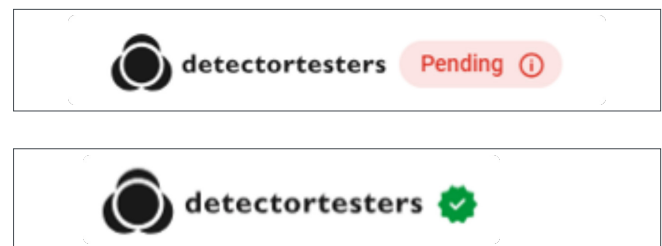

### 8.3.3 Cancelling a Subscription

To unregister a device and cancel its subscription, click “Manage Subscriptions” and follow the instructions to cancel your plan (Fig. 40)

**Figure 40**

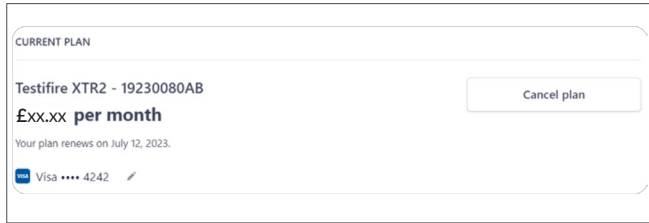

Once the subscription is cancelled, click the bin icon to the right-hand side of the tester you wish to remove.

**NOTE:**

Devices must be unregistered before they can be registered to a new company.

### 8.4 Managing Test Reports

All test jobs created in the app are saved on the cloud portal and are accessible through the reports tab. The reports tab provides a summary view of all completed test jobs, this can be viewed or downloaded (PDF or CSV file).

**Figure 41**

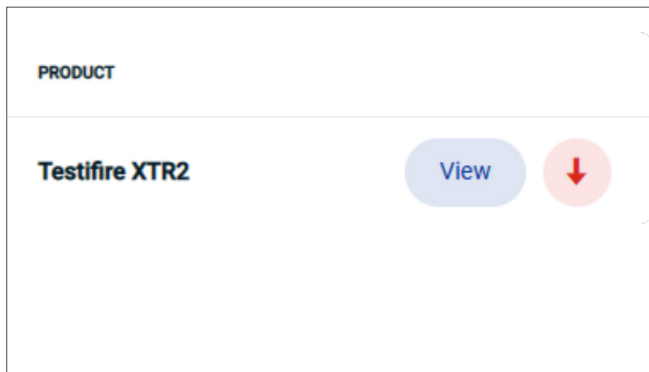

To view more details about a Test Job, click the “View” option from the right-hand side of the test summary. The detailed view shows additional information about the Test Job, including:

- Individual tests results
- Start time of individual tests
- Test notes
- Test count by test mode (e.g. smoke)
- Total test count
- Other equipment tested (e.g. batteries)
- Additional notes
- Site owner and signature

### 8.5 Managing Technicians

Technicians need to be registered in order to use a company’s Testfire XTR2. To add a technician go to “Technicians Tab” and click on “Add New User” (Fig 42.1)

**Figure 42.1**

LOCATION/COMPANY	TECHNICIAN	DATE	TEST TIME	SERIAL NO.	PRODUCT
Nissan	Martin Obble	13.11.2023	1m	11230095CA	Testfire XTR2
Nissan	Martin Obble	13.11.2023	4m	11230095CA	Testfire XTR2
Sumbawa Mitsui Banking Corporation Gostada Branch	Martin Obble	13.11.2023	1m	11230095CA	Testfire XTR2
Starbucks Coffee - Gostada Tokyo Square	Martin Obble	13.11.2023	1m	11230095CA	Testfire XTR2
SABSON Bakery/Coffee	Martin Obble	13.11.2023	1m	11230095CA	Testfire XTR2
Tokyo Square Gostada	Martin Obble	13.11.2023	1m	11230095CA	Testfire XTR2
HOCHTI Headquarters	Martin Obble	16.11.2023	1m	11230095CA	Testfire XTR2
Pine Street Farm	Martin Obble	08.11.2023	1m	11230095CA	Testfire XTR2
ADI Global Distribution - Oldham Branch	Alex Brown	01.11.2023	1m	42230097CA	Testfire XTR2
ADI Global Distribution - Oldham Branch	Alex Brown	01.11.2023	1m	42230097CA	Testfire XTR2
ADI Global Distribution - Oldham Branch	Alex Brown	01.11.2023	1m	42230097CA	Testfire XTR2
ADI Global Distribution	Dominic Palmer	31.10.2023	1m	12230029CA	Testfire XTR2
ADI Global Distribution	Dominic Palmer	31.10.2023	1m	12230029CA	Testfire XTR2
Detector Testers	Dominic Palmer	26.10.2023	1m	12230029CA	Testfire XTR2
Carotech Fire Systems Limited	Simon Flavell	27.10.2023	3m	12230077CA	Testfire XTR2

The Technicians tab provides a summary of users registered to your company, including:

- Full name
- Email address
- Admin access

To edit a user’s details, click the edit technician icon to the right-hand side of the user summary. First name, last name, email address and admin access can all be updated (Fig. 42.2)

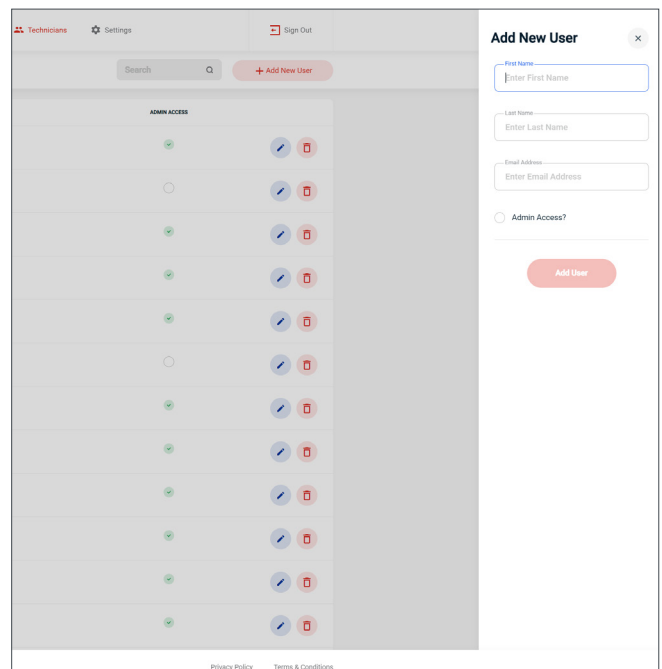

**Figure 42.2**





To remove a user, click the remove technician icon to the right-hand side of the user summary and then click “Yes” to confirm (Fig. 43).

**Figure 43**

FULL NAME	EMAIL ADDRESS	ADMIN ACCESS	
Paul Turner	testifireconnect@detectortesters.com	<span>✓</span>	 

**NOTE:**  
New technicians will receive an email prompting them to claim their account by setting up a password. If it has not been claimed within 24 hours invitation will expire and will need to be resent.

### 8.6 Settings Menu

The Settings menu can be used to manage a number of details and preferences, including:

- Company logo
- Company details
- Profile details
- User password

#### 8.6.1 Uploading a Company Logo

To upload a company logo, click “Upload Logo”. Select your logo from the browser and click “Open (Fig. 44).

**NOTE:**  
To remove a company logo, click the delete

**Figure 44**

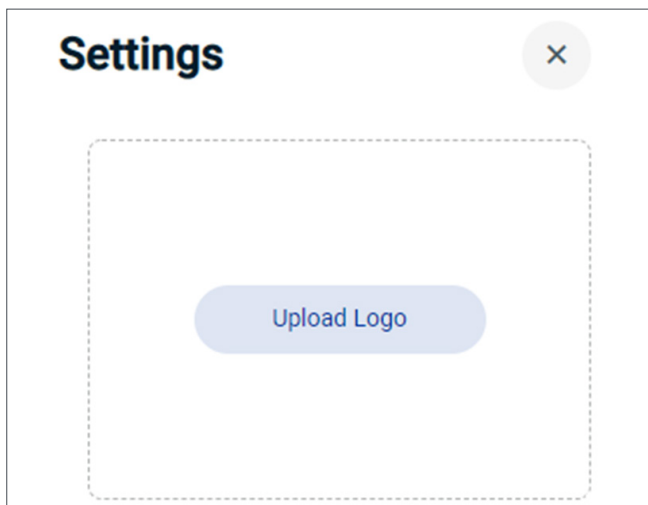

#### 8.6.2 Company Details

The “Company Details” section can be used to edit company information, including company name, address, postcode and country. (Fig. 45).

**Figure 45**

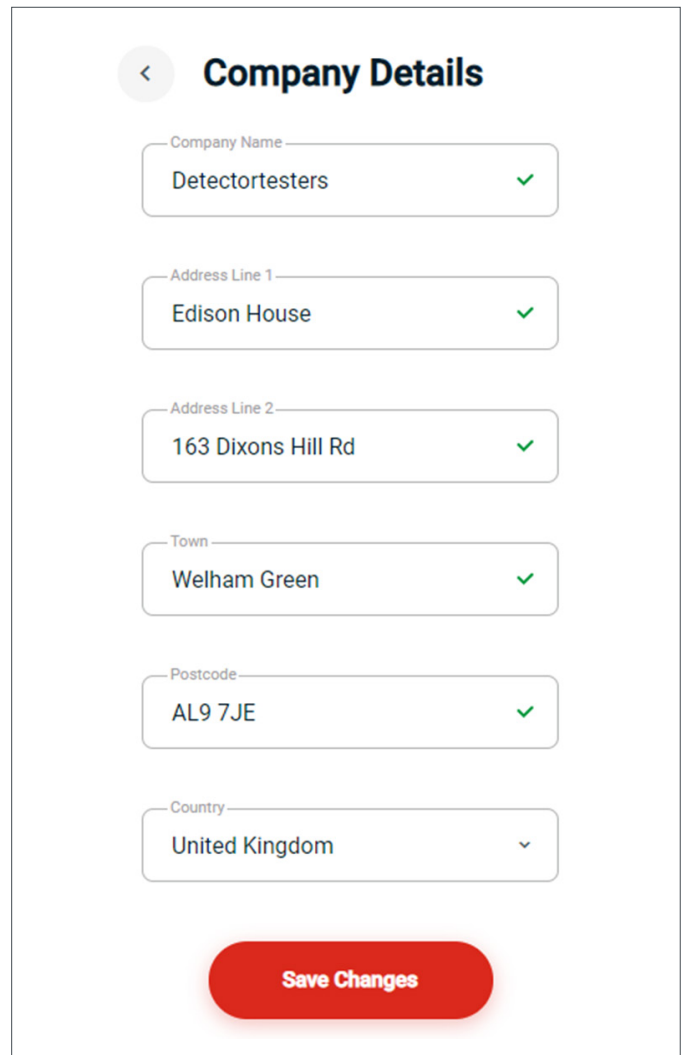

The image shows a 'Company Details' form with a back arrow in the top left. The form contains the following fields, each with a green checkmark indicating it is filled:

- Company Name: Detectortesters
- Address Line 1: Edison House
- Address Line 2: 163 Dixons Hill Rd
- Town: Welham Green
- Postcode: AL9 7JE
- Country: United Kingdom (dropdown menu)

A red rounded rectangular button labeled 'Save Changes' is located at the bottom of the form.

### 8.6.3 Profile Details

The “Profile Details” section can be used to edit company profile information, including email address and Country. (Fig. 46).

**Figure 46**

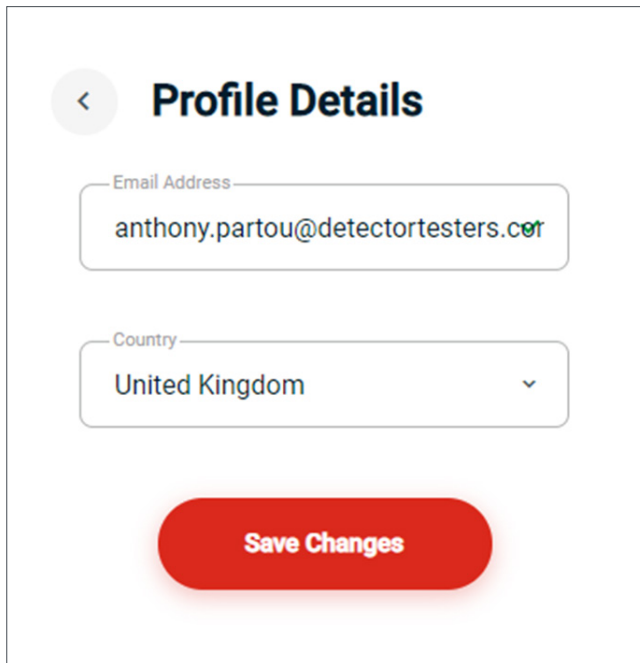

The screenshot shows a mobile application interface for editing profile details. At the top left is a back arrow icon. The title "Profile Details" is centered at the top. Below the title are two input fields: "Email Address" containing the text "anthony.partou@detectortesters.com" and "Country" with a dropdown menu showing "United Kingdom". At the bottom center is a red rounded button labeled "Save Changes".

### 8.6.4 Changing Password

To change your password, click “Change Password”. Enter your current password followed by your new password, then click “Save Changes”. (Fig. 47).

**Figure 47**

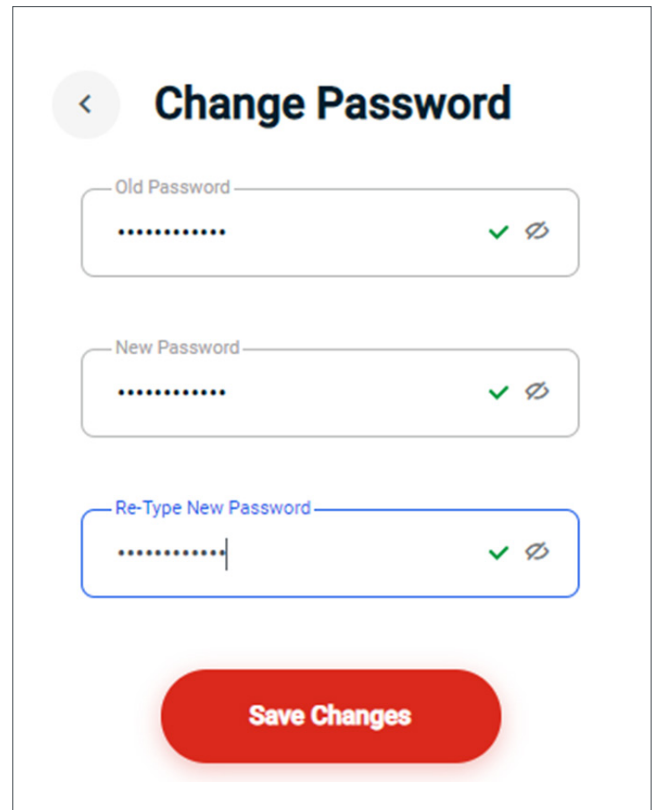

The screenshot shows a mobile application interface for changing a password. At the top left is a back arrow icon. The title "Change Password" is centered at the top. Below the title are three input fields: "Old Password", "New Password", and "Re-Type New Password". Each field contains a series of dots representing masked text and has a green checkmark and a toggle icon to its right. At the bottom center is a red rounded button labeled "Save Changes".

# 9 DETECTORTESTERS CONNECT APP

## IMPORTANT:

To generate test reports technicians must use the app with their Testifire XTR2 device.

The DT Connect app provides a number of features and benefits to help you make the most of your Testifire XTR2. This includes access to advanced test modes and digital test reports that provide proof of compliance.

## 9.1 Downloading the App

The DT Connect app can be downloaded from the App Store for iPhone and the Google Play Store for Android devices. The following smartphones are supported:

- Apple iPhone with iOS 12 or later
- Android OS 8 or later

## 9.2 Signing In

Once you have downloaded the DT Connect app, Tap “Get Started” to sign in (Fig. 48).

Figure 48

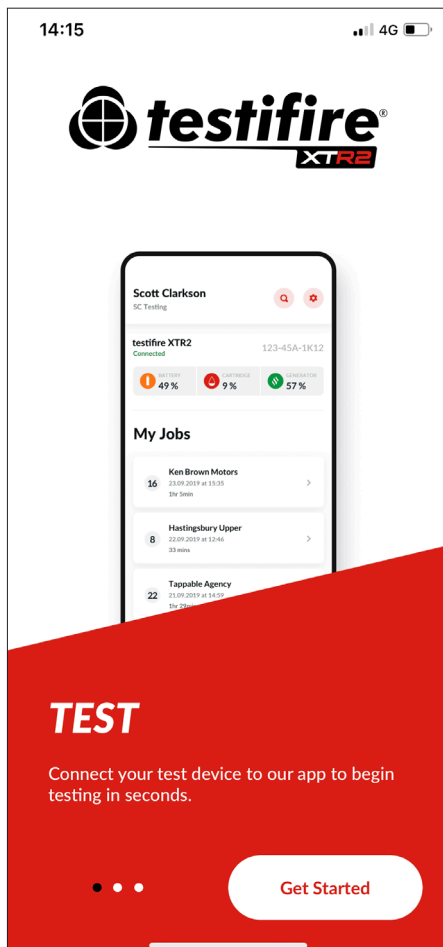

Enter the same email address used to register your account in the Cloud Portal (Section 8.1) and tap “Next” (Fig. 49)

Figure 49

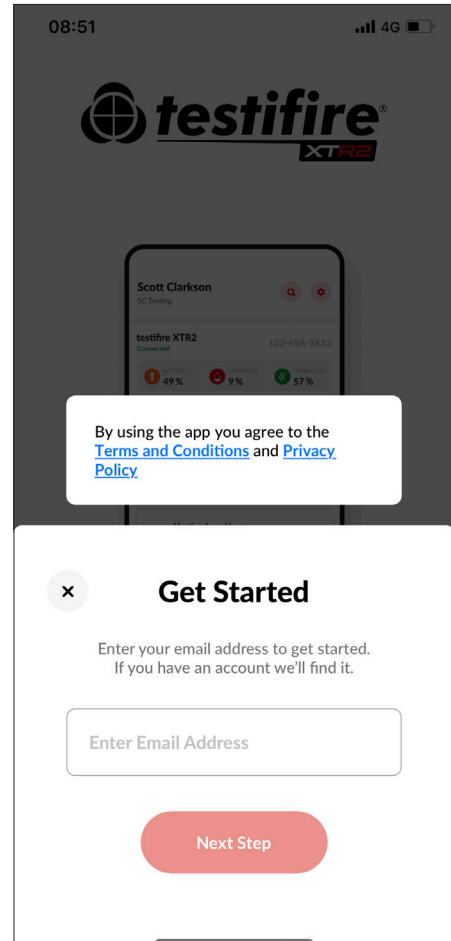

Enter your password and tap “Next” (Fig. 50)

**Figure 50**

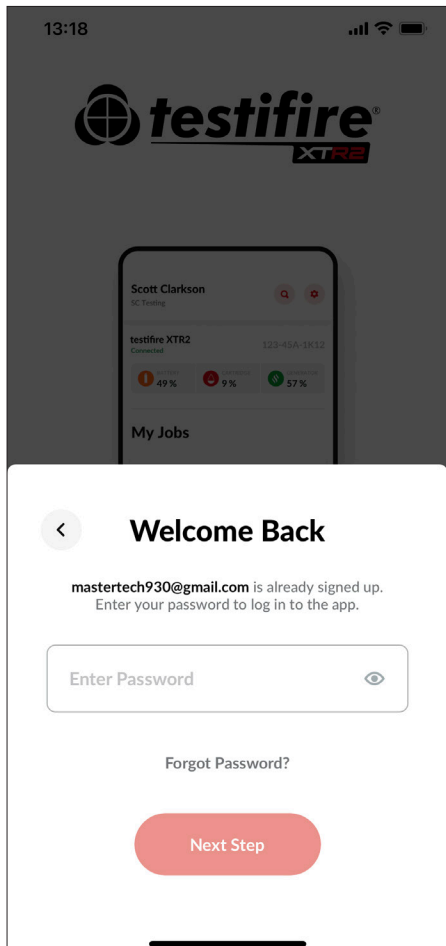

If your company is already registered with DT Connect and they have not pre-registered your account, you will be asked to create a new profile (Fig. 51)

**Figure 51**

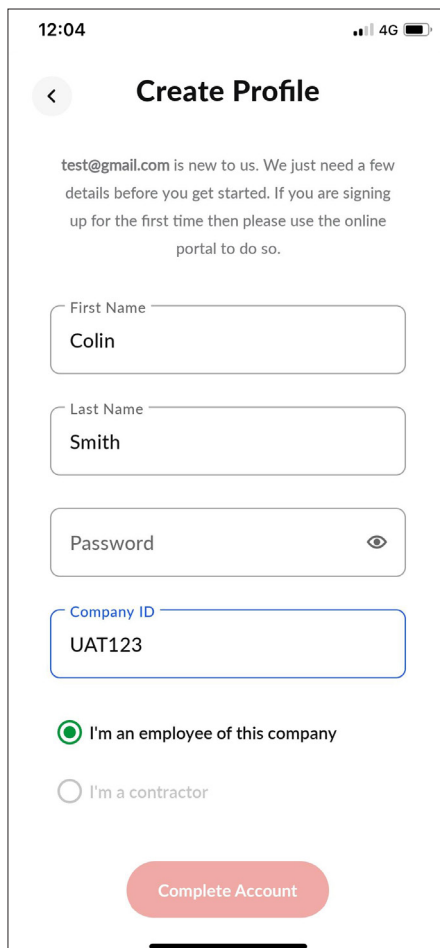

**NOTE:**  
A company ID is required to register a new profile in the DT Connect app. If you do not have this, ask your administrator to register your account in the Cloud Portal (Section 8.5)

### 9.3 Pairing your Testifire XTR2

Once Testifire XTR2 is registered to your company, pair it with the DT Connect app (Fig. 52)

1. Tap “Connect Device” on the home screen
2. Select your Testifire XTR2 device from the device list and tap “Confirm”
3. Enter the Bluetooth passcode displayed on your Testifire XTR2 display
4. Once your Testifire XTR2 is connected its serial number and consumables status are shown on the app home screen.

Figure 52

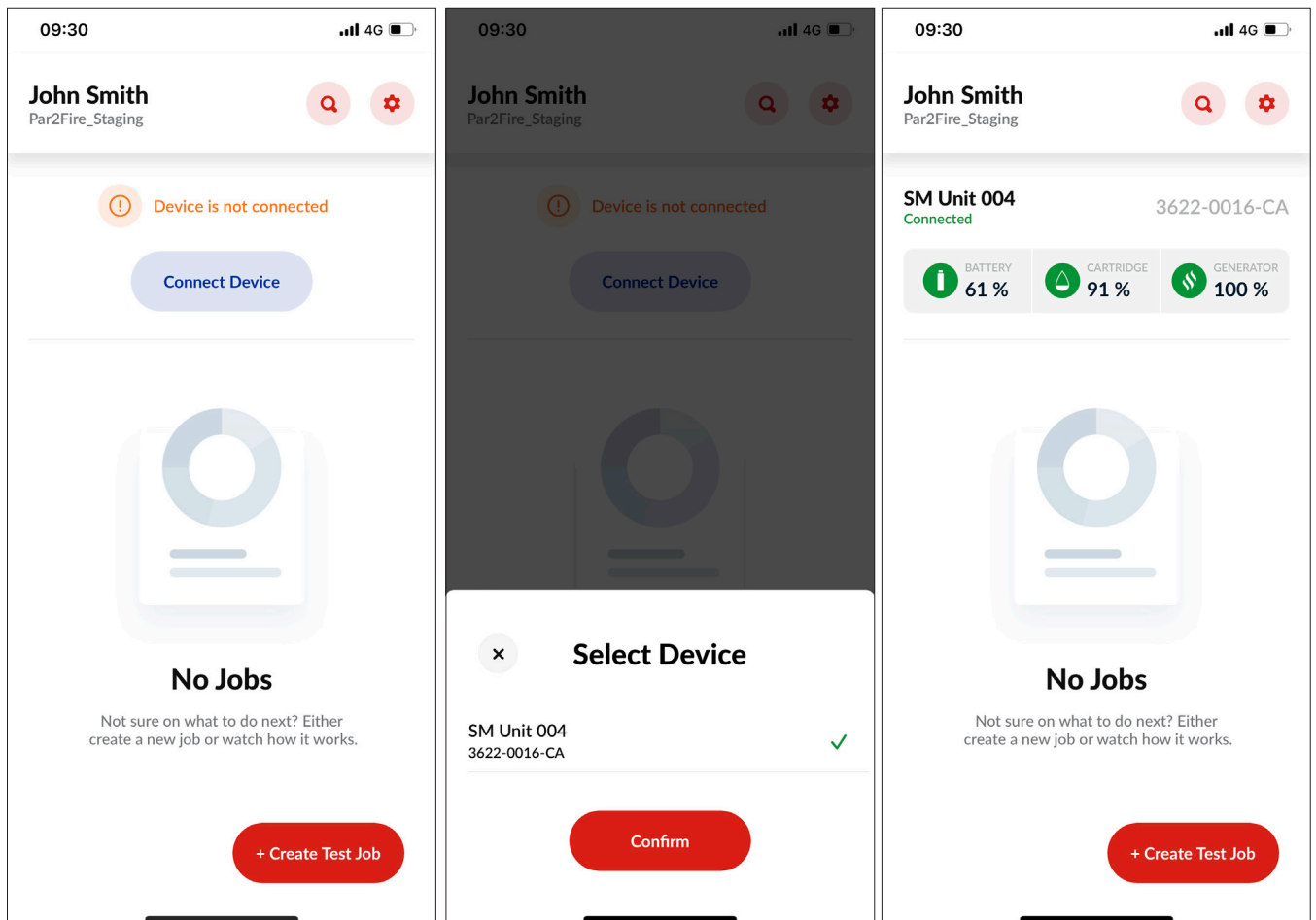

## 9.4 Creating a New Test Job

To generate a test report, tap the “Create Test Job” icon in the bottom right-hand corner of the home screen

Select a test site from the nearby locations or use the search function. If you cannot find your location, tap “Can’t See Location?” and enter the address details manually (Fig. 53).

Figure 53

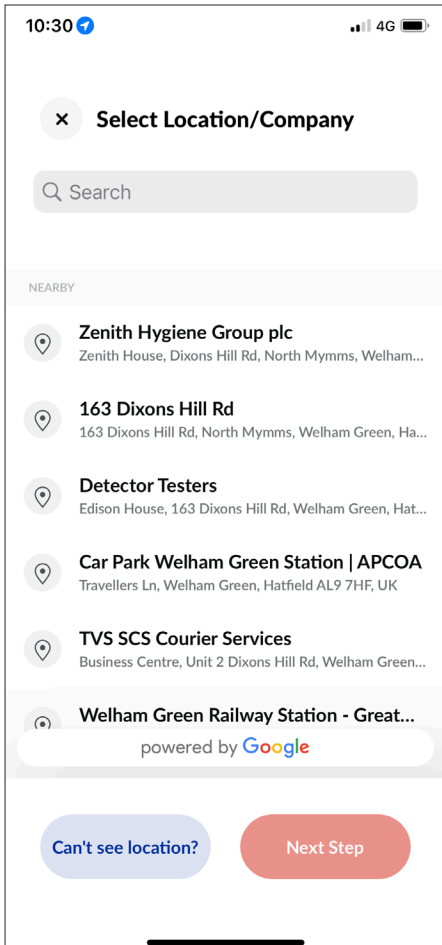

Select a test mode and tap “Start Test”. (Fig. 54)

Figure 54

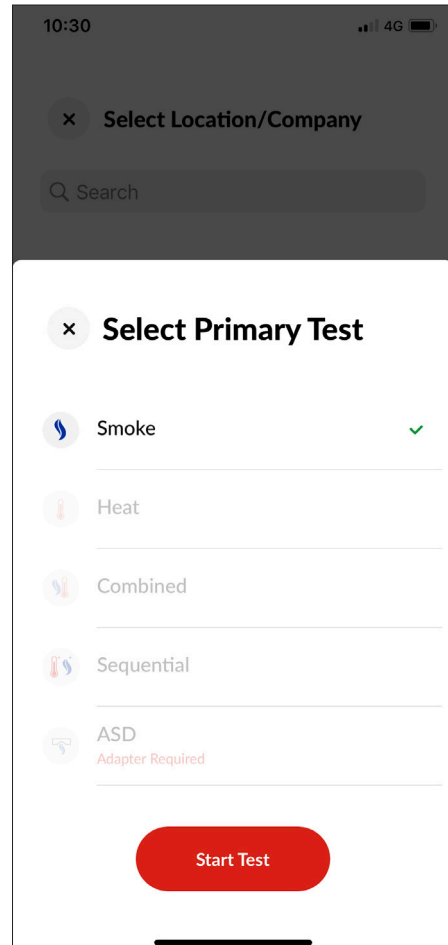

**NOTE:**  
The test mode can be changed at any time after starting a test job

## 9.5 Performing a Test

An infrared beam across the tester cup controls the test. The test will begin automatically when the tester cup is placed over the detector, breaking the infrared beam. The app will indicate a test is in progress and that it is awaiting the result (Fig. 55).

Figure 55

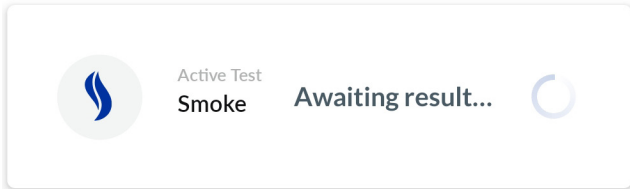

When the detector is activated, the optical LED reader inside the tester cup will sense the detector activation LED and automatically end the test. The app will indicate the test was successful by displaying "Passed" in green and you should remove Testifire XTR2 by gently lowering it. The result will be added to the Test Job record and optional notes can be added to the record (Fig. 56).

Figure 56

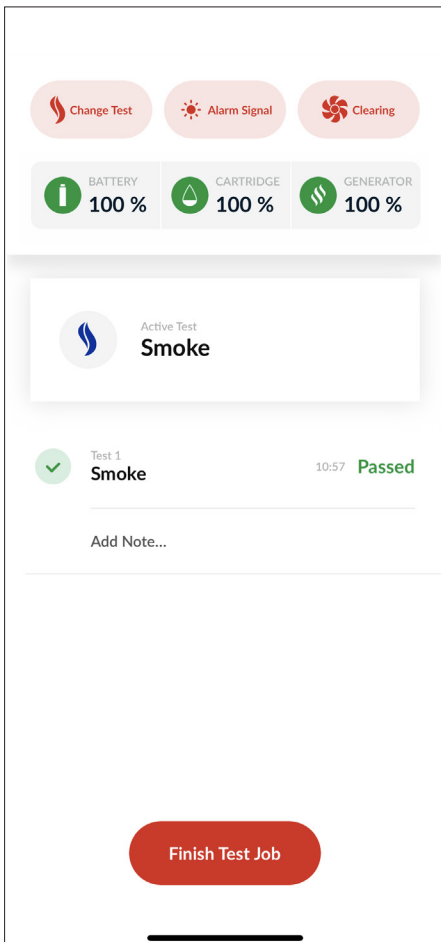

If after two minutes the test has not completed, Testifire XTR2 will time-out and the test will be recorded as failed. The app will indicate the test was unsuccessful by displaying "Failed" in red and you should remove Testifire XTR2 by gently lowering it. The result will be added to the Test Job and a prompt will appear to add notes (Fig. 57).

Figure 57

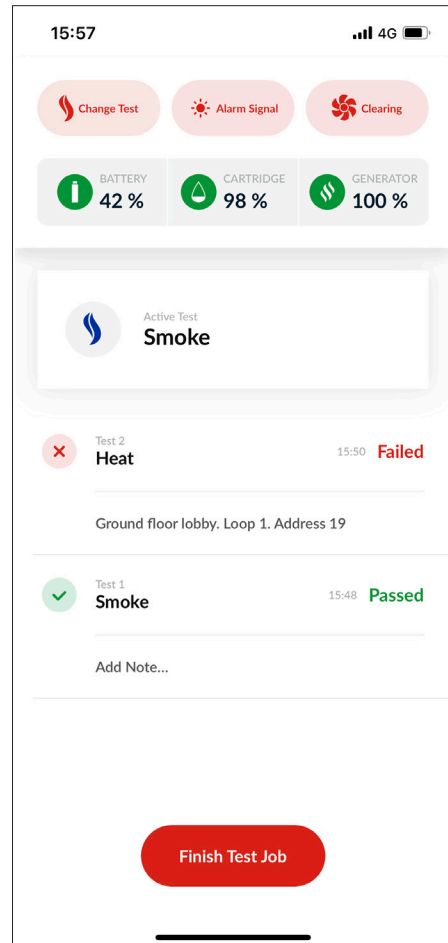

### NOTE:

Adding test notes are compulsory for failed tests and must be added before a Test Job can be closed. It is not compulsory to add notes to passed tests.

### 9.5.1 Aborted Tests

An active test can be aborted before it is completed by removing the detector and gently lowering Testifire XTR2. The app will indicate the test was aborted and a prompt will appear with options to either retry the test or manually override the result (Fig. 58).

When choosing the “Override Result” option, you will be prompted to manually select if the test has passed or failed and you will need to add notes against the test record. This option is intended for use when the optical LED reader inside the tester cup has not sensed the detector activation LED, or when a test was started accidentally (Fig. 59).

Figure 58

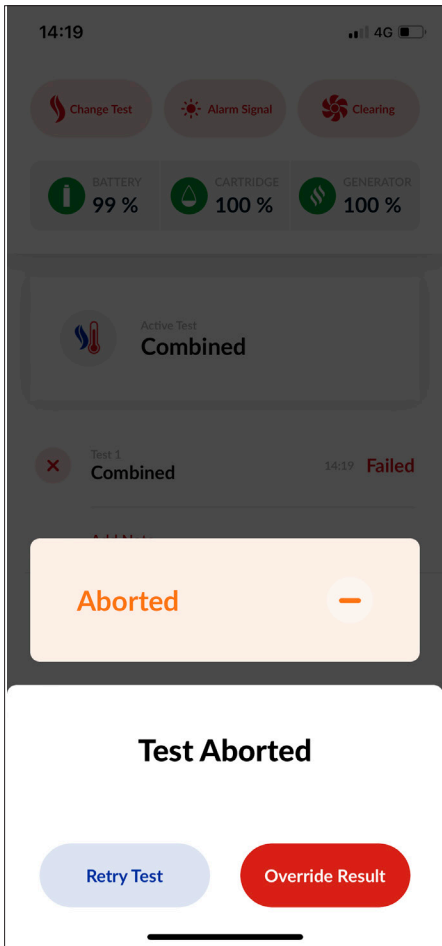
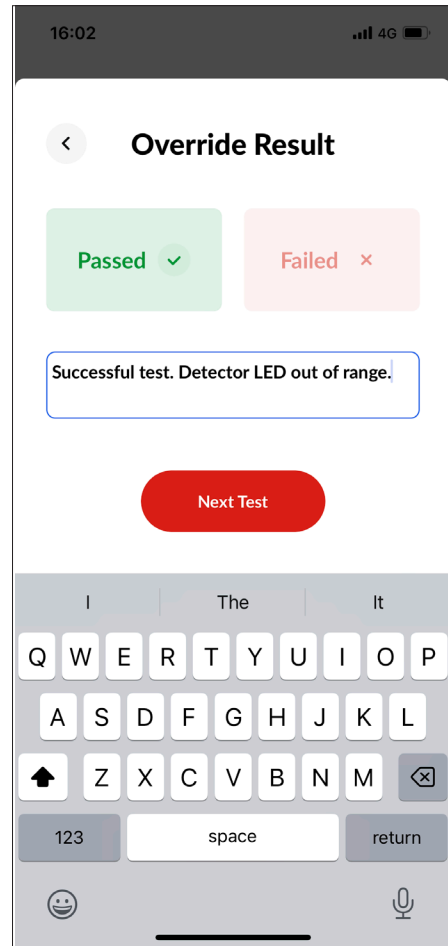

Figure 59





## 9.5.2 Changing Test Mode

To change test mode, tap “Change Test” and select a new test mode from the list (Fig. 60). When a new mode is selected the status LED’s on Testifire XTR2 will change to indicate the selected mode (see section 4.3)

Figure 60

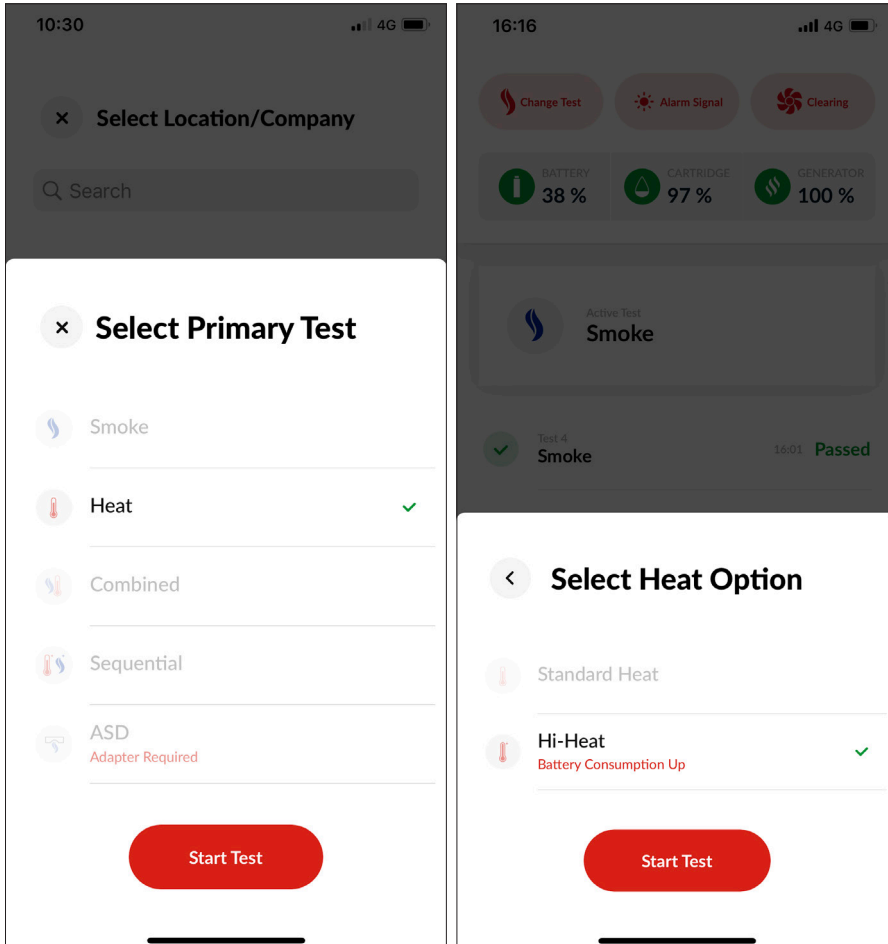

**NOTE:**

Hi-Heat mode can be chosen after selecting Heat mode.

### 9.5.3 Changing Alarm Signal Mode

Different detector brands and models have different LEDs. Some detectors have a blinking red LED, some have solid red LED. The LED detection mode needs to be in the appropriate mode. In case Testifire XTR2 is not picking up the LED, the most likely resolution is to switch the detection mode. To change alarm detection mode, tap “Alarm Signal” and choose between solid or flashing LED detection modes (Fig. 61)

Figure 61

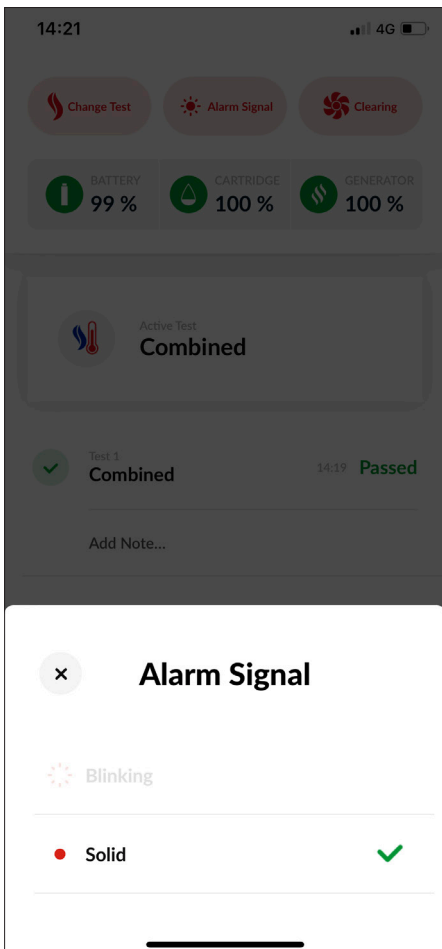

**NOTE:** The correct alarm detection mode must be set for the detector under test. Selecting the wrong mode will prevent the optical LED reader inside the test cup from sensing the detector activation LED.

### 9.5.4 Manual Clearing

Once a detector is activated, lingering smoke can be cleared from the detector using the Clearing mode. Air is blown around the detector – clearing any lingering smoke via the vent in the cup.

Select the clearing mode by tapping “Clearing” in the top right hand corner. Once selected, the status LED’s on Testifire XTR2 will change to solid white (Fig. 62)

Figure 62

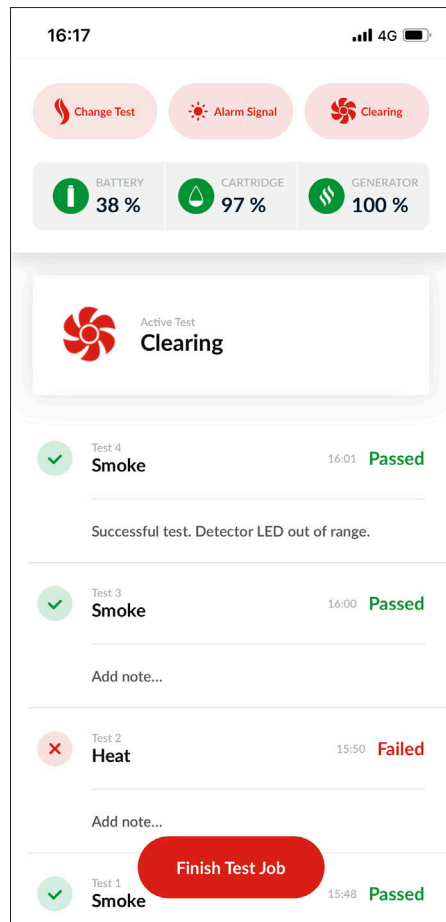

**NOTE:** To perform automatic clearing after a smoke, combined or sequential tests, continue to hold Testifire XTR2 over the detector. If the test was successful, clearing will begin automatically and the status LED’s will flash white.

### 9.5.5 Using the Delayed Start mode

ASD systems and Flat Detectors can be tested using the ASD Adaptor (Product Code: TESTIFIRE-ADAP-001). See section 6.2 for guidance on fitting the adaptor to the Testifire XTR2 test cup.

Change the test mode to ASD once the ASD adaptor is installed and select a delay duration of either 5, 20 or 40 seconds (Fig. 63)

Figure 63

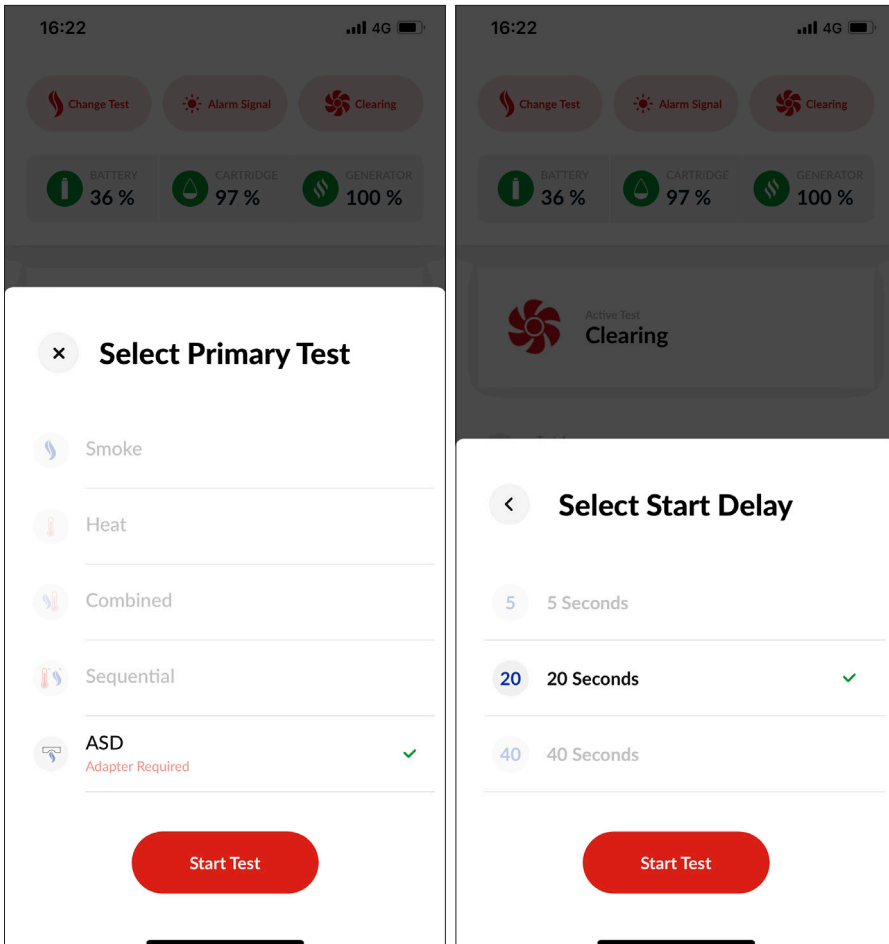

Tap “start” when you are ready to begin the timer and begin positioning Testifire XTR2 (Fig. 64)

**Figure 64**

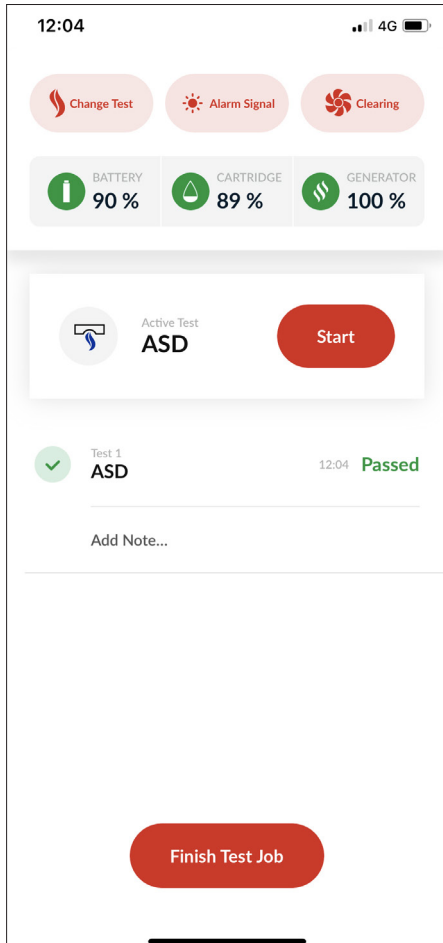

## 9.6 Closing a Test Job

Close the Test Job when all testing is complete by tapping “Finish Test”.

Select any additions you have tested whilst on site and add optional notes to give more detail, then tap “Next” (Fig. 65).

**Figure 65**

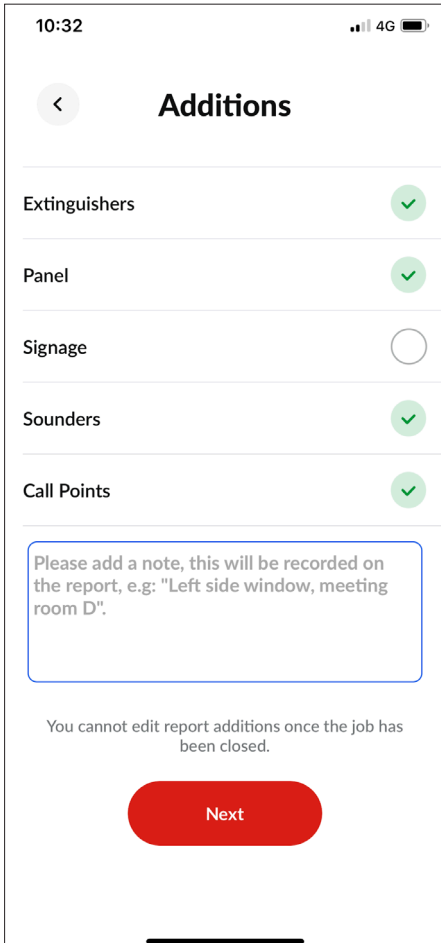

Review the summary of the Test Job on the Preview page and add any final test notes before tapping “Next” (Fig. 66)

**Figure 66**

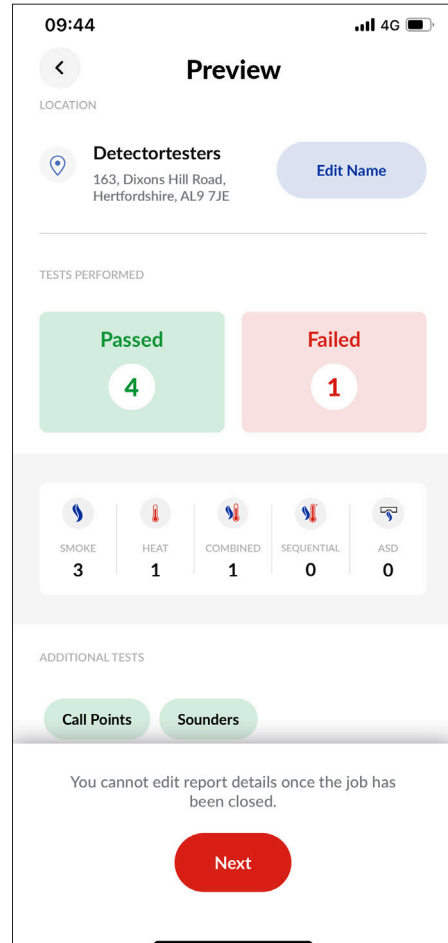

An optional signature can be obtained from the client before closing the Test Job. If required, have the client sign off the job with their signature and details before tapping "Close Test Job" (Fig. 67).

**Figure 67**

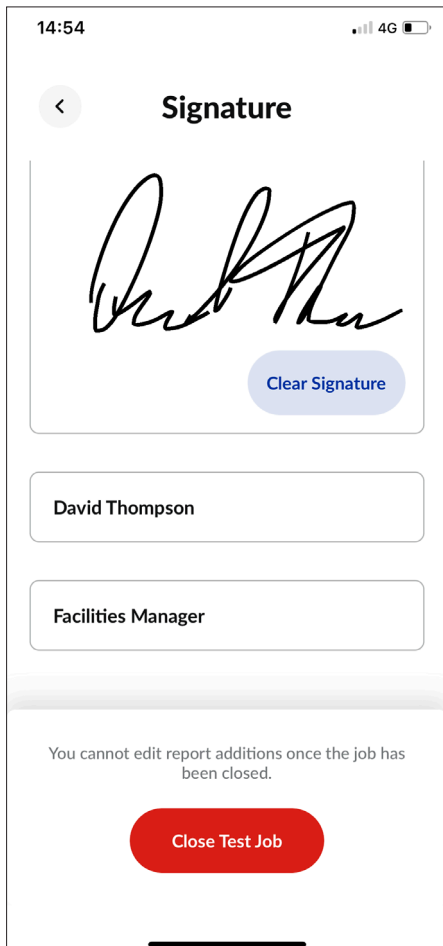

**NOTE:**  
Test details cannot be edited after the job is closed. Ensure all testing is complete with appropriate notes before closing a Test Job.

## 9.7 Sharing a Test Report

Once a Test Job is closed it will be listed on the “My Test Jobs” dashboard on the home screen (Fig. 68)

To view a summary, tap the desired job from the My Test Jobs dashboard or use the Search function (Fig. 69)

Figure 68

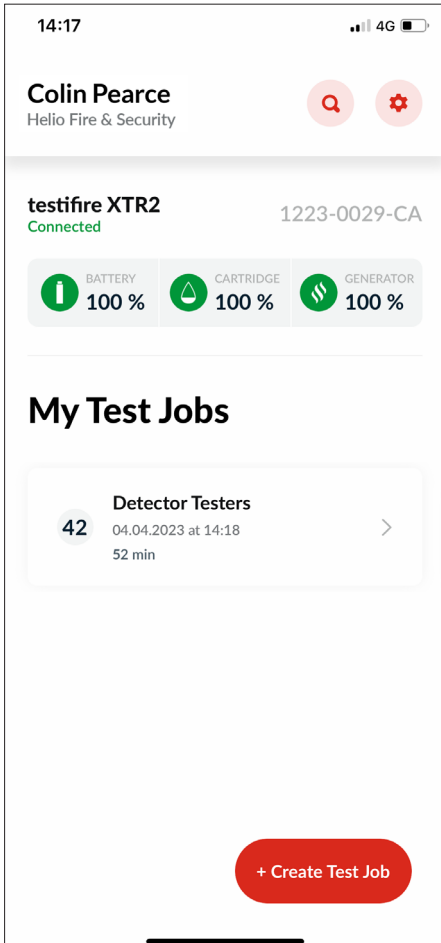
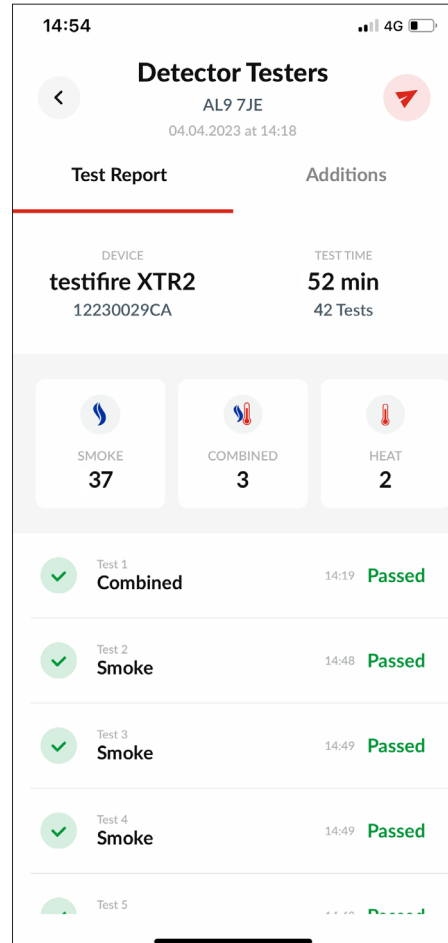
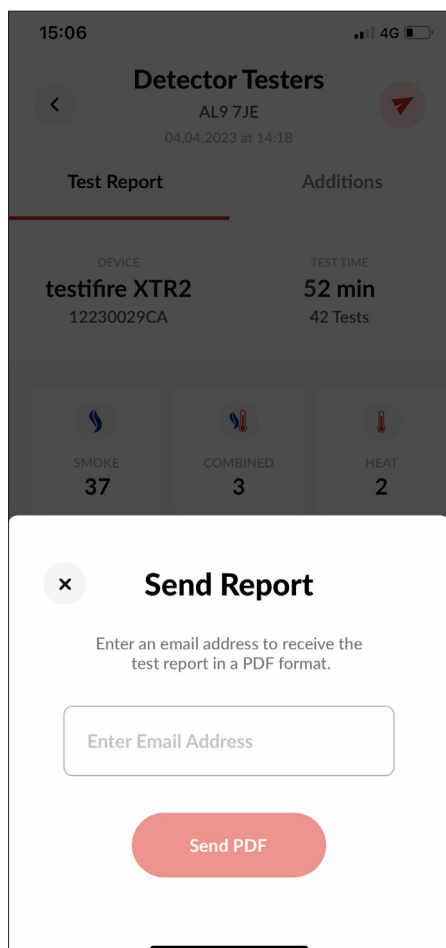

Figure 69



To share a PDF test report, tap the share icon in the top right and enter the recipients email address (Fig. 70)

**Figure 70**





## 9.8 App Settings Menu

The Settings menu provides access to account information, app settings and troubleshooting information (Fig. 71)

Figure 71

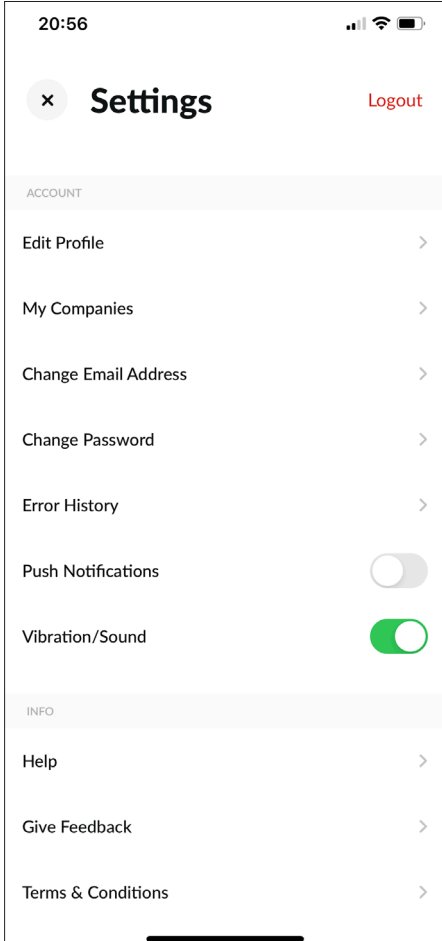

### 9.8.1 Edit Profile

Select this option to update account information including first name, last name and country of use.

### 9.8.2 My Companies

Select this option to view the companies the account is associated with and to connect a new company using a company registration code.

### 9.8.3 Change Email Address

Select this option to update the email address for the account. You will be required to enter your old and new email address.

### 9.8.4 Change Password

Select this option to update the password for the account. You will need to enter your old and new password.

### 9.8.5 Error History

This menu includes a list of all device errors and enables direct contact with Detectortesters Support by phone or email.

### 9.8.6 Push Notifications

Enable this option to receive push notifications from the DT Connect app on your mobile device.

### 9.8.7 Vibration/Sound

Enable this option for vibration and sounds from the DT Connect app on your mobile device.

### 9.8.8 Help

The DT Connect app includes access to a range of help and support videos so you can make the most of Testifire XTR2. To access the content, tap the settings icon in the top right hand corner from the home screen and select the "Help" option.

A manual purge may be required when the unit has not been used for a period of time, when in cold conditions, a new generator has been installed or in the case of a significant drop in performance. To perform a manual purge, tap the manual purge option from the bottom of the help menu (Fig. 72)

Figure 72

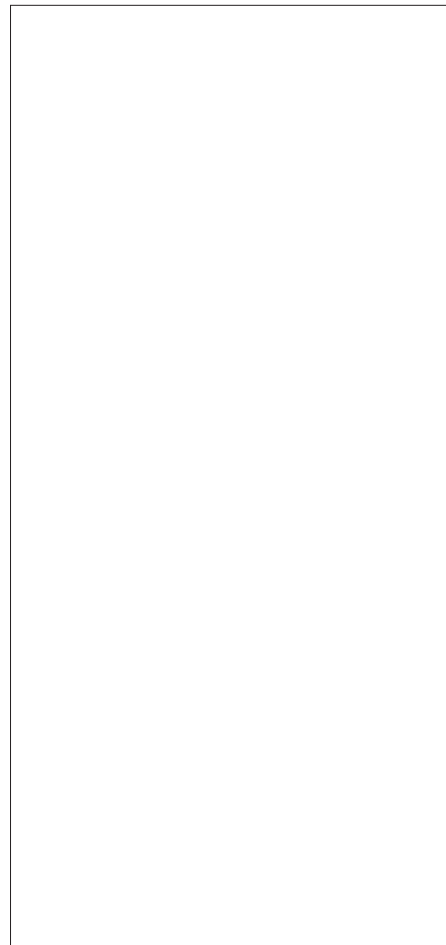

**NOTE:**

A manual purge should only be carried out in a well ventilated area (see Section 5.8 Manual Purge).

### **9.8.9 Give Feedback**

Select this option to give us your feedback on the DT Connect app

### **9.8.10 Terms & Conditions**

This menu allows you to view the latest Terms & Conditions for DT Connect

### **9.8.11 Privacy Policy**

This menu allows you to view the latest Privacy Policy from Detectortesters

### **9.8.12 Deactivate Account**

Select this option to deactivate your account. This action is irreversible

# 10

## CONSUMABLES AND ACCESSORIES

### Consumables

TES3-3PACK-001	Testifire XTR2 Smoke Cartridges x3
TES3-6PACK-001	Testifire XTR2 Smoke Cartridges x6
TESTIFIRE-GEN-1PK-001	Testifire XTR2 Smoke Generator x1
TESTIFIRE-BP-001	Testifire XTR2 Lithium Ion Battery Pack x1

### Accessories

TESTIFIRE-ADAP-001	Testifire XTR2 ASD Adaptor
TESTIFIRE-FA-001	Testifire XTR2 Heat Deflector

### Spares

TESTIFIRE-CHAK-001	Testifire XTR2 Charger Kit
TESTIFIRE-CHA-001	Testifire XTR2 Battery Charge Cradle
TESTIFIRE-WPSU-001	Testifire XTR2 Mains Power Adaptor
TESTIFIRE-CPSU-001	Testifire XTR2 Car Power Adaptor
TESTIFIRE-USBC-001	Testifire Charger lead (USB-C to USB-C)
TESTIFIRE-MEM-001	Replacement Membrane for Testifire XTR2
TESTIFIRE-MEML-001	Testifire XTR2 membrane (Large)
TESTIFIRE-SOP-001	Replacement Stand off Plate for Testifire XTR2

# TROUBLESHOOTING

If when testing, a detector does not activate, the status LED's will display a triple red flash. If this occurs you should confirm the following:

1. The correct test mode is selected
2. The optical LED reader is configured to respond to the correct detector behaviour (solid or flashing, see section 5.9 Device Settings)

Repeat the test again up to 2 more times by removing and replacing the unit over the detector. If the detector still does not activate it may be faulty and need replacement.

## Unit does not switch on

Remove the battery and check the charge indicator. If empty, recharge the battery. (Fig. 73).

Figure 73

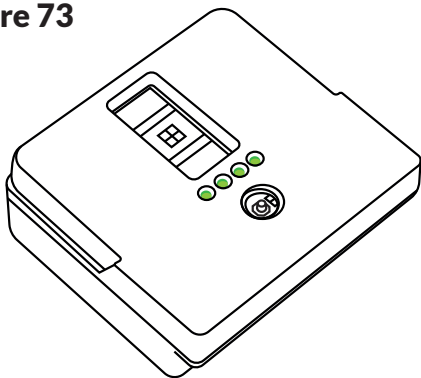

## Fan is not rotating

Check for obstructions. Use an air duster to clear debris

## The status LED's turn purple

A fault has occurred and an error code will be shown on the LCD display. Error codes represent a unique fault and require different actions to resolve. See section 11.1 for more detail on individual error codes and required actions.

1. Power the unit off and on again.
2. Power the unit off and remove the battery. Remove and re-insert the generator and check the PCB contacts for any debris. Wipe clean with a lint free cloth if necessary.
3. Check the fan moves freely, if not remove the smoke cartridge and generator from within Testifire XTR2. Fan faults may occur due to debris getting inside the unit. Carefully use an air duster and apply to the fan or rotate the fan gently. The use of an air duster normally frees the fan of debris. Re-insert the battery and power the unit on.
4. If the problems remain, please contact [support@detectortesters.com](mailto:support@detectortesters.com)

## Smoke not being generated

If the fluid indicator is empty change the smoke cartridge. If the generator indicator is displayed change the generator. (Fig. 74).

Figure 74

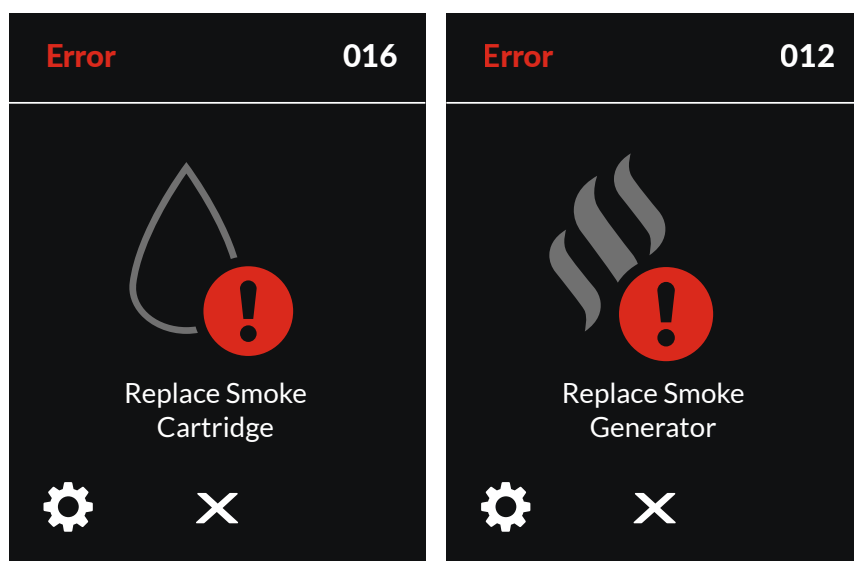

## 11.1 Device Error Codes

In the event of a system fault, Testifire XTR2 will display an error code on the LCD display. Every error code is unique and represents a different fault.

Error Code	Description	Required Action
1	Unit deactivated at first power on due to no connection to DT Connect App	Pair Testifire XTR2 to the DT Connect App
2	Unit deactivated by external command	Contact Product Support to reactivate
3	Fan jammed or stalled	Power the unit off. Check the fan moves freely, if not remove the smoke cartridge and generator. Use an air duster or rotate the fan gently
4	Fan rotating, but cannot be controlled to setpoint RPM	Power the unit off. Check the fan moves freely, if not remove the smoke cartridge and generator. Use an air duster or rotate the fan gently
6	Short circuit on heat element	Power the unit off. Remove the battery and wait 30 seconds. Reinsert the battery and retry
7	Heat element out of temperature range	Power the unit off. Remove the battery and wait 30 seconds. Reinsert the battery and retry
9	Short circuit on smoke element	Replace smoke generator
10	Smoke element out of temperature range	Replace smoke generator
11	Smoke generator not detected	Power the unit off. Remove the battery, smoke cartridge and smoke generator. Reassemble in reverse order and retry
12	Replace smoke generator	Replace smoke generator
15	Smoke cartridge not detected	Power the unit off. Remove the battery, smoke cartridge and smoke generator. Reassemble in reverse order and retry
16	Replace smoke cartridge	Replace smoke cartridge
19	No communications to sensor board	Power the unit off. Remove the battery and wait 30 seconds. Reinsert the battery and retry
20	IR sensor error	Power the unit off. Clean IR sensor and restart device
23	Ambient light level in cup too high to detect LED	Ambient light in cup too high for LED recognition
25	Unit powered but no coms to battery pack	Power the unit off. Remove the battery and wait 30 seconds. Reinsert the battery and retry
26	Battery not authenticated	Replace battery with approved Testifire XTR2 spares (see section 10)
30	Battery temperature out of limits	Battery temperature too high
31	Battery charge empty	Recharge battery
34	RTC not initialised	Pair Testifire XTR2 to the DT Connect App
37	Smoke element over current limit	Replace smoke generator
39	Heat element over current limit	Power the unit off. Remove the battery and wait 30 seconds. Reinsert the battery and retry
43	Bluetooth module error	Power the unit off. Remove the battery and wait 30 seconds. Reinsert the battery and retry
44	Smoke generator not authenticated	Replace smoke generator with approved Testifire XTR2 spares (see section 10)
45	Smoke cartridge not authenticated	Replace smoke cartridge with approved Testifire XTR2 spares (see section 10)

### **12.1 Maintenance**

The Testifire XTR2 unit contains no user serviceable parts. Do not disassemble. In the case of a build-up of dust or dirt on the surface of the product, wipe with a slightly damp lint-free cloth.

The area around the smoke/heat duct and within the cup should be cleaned periodically to remove any dirt or fluid.

This can also be done using a slightly damp lint-free cloth. Do not use detergents, cleaning materials or solvents such as petroleum spirit, benzene or methylated spirit to clean the product.

<https://detectortesters.com/troubleshooting>

## 12.2 Technical Information

<p>Operating features:</p>	<ul style="list-style-type: none"> <li>• Electronic smoke stimulus</li> <li>• Heat stimulus (standard / hi-heat)</li> <li>• Automatic smoke clearing function</li> <li>• Optical sensors to automatically capture detector led alarm status</li> <li>• TFT-LCD full colour touch screen</li> <li>• Colour led user feedback up to 9m visual distance</li> <li>• Automatic torch in dark environment</li> <li>• Adjustable multi-position head</li> <li>• BT enabled to communicate with detectortesters-connect app</li> <li>• Optional subscription for premium features in the DT Connect app and Cloud Portal</li> </ul>
<p>Safety features:</p>	<p>General safety features</p> <ul style="list-style-type: none"> <li>• Auto-shutdown feature. If the unit is inactive for more than 10 minutes, the unit automatically shuts down which disconnects the control circuit from the battery pack.</li> <li>• All tests are time limited to 120 seconds.</li> </ul> <p>Heater/smoke safety features:</p> <ul style="list-style-type: none"> <li>• Microprocessor in-test temperature and voltage safety monitoring stops test in response to fault</li> <li>• INA230 current alert function stops test in response to fault</li> <li>• Fuse protection if heater/smoke element overheats</li> </ul> <p>Battery pack safety features:</p> <ul style="list-style-type: none"> <li>• The battery pack features safety circuits to prevent over temperature, over current, over charging and deep discharge conditions.</li> <li>• Microprocessor in-test temperature safety monitoring displays LCD warning and prevents further tests until battery cooldown</li> <li>• JEITA compliant charge cycle limiting charge current and voltage dependant on temperature</li> </ul>
<p>Power source:</p>	<p>Lithium ion battery pack nominal 10.8v 35.1wh/3250mah, with USB-C connection to charging cradle</p>
<p>Battery charging time:</p>	<p>50% charge 23°C: Less than 1 hour</p> <p>Fully charged: 5°C = 3 hours 23°C = 2 hours 40°C = 3 hours</p>
<p>Power consumption:</p>	<p>Dependent on mode of use:</p> <p>Smoke testing: &lt;0.5A rms Heat testing: 4-6A rms</p> <p>N.B. Power consumption refers only to the duration of the actual test and may vary considerably due to internal control algorithms.</p> <p>-----</p>

Test modes:	<ul style="list-style-type: none"> <li>• Smoke: a simulated smoke generated internally using a miniature heat exchanger and a harmless liquid from the smoke capsule.</li> <li>• Standard Heat: to test rate-of-rise and fixed temperature heat detectors up to 90°C (194°F).</li> <li>• Hi-Heat: to test rate-of-rise and fixed temperature heat detectors up to 100°C (212°F).</li> <li>• Clearing: clean air is blown to remove previously applied smoke.</li> <li>• Simultaneous Testing: Smoke and Heat in combination</li> <li>• Sequential Testing: Heat followed by Smoke</li> <li>• Smoke for ASD or flat detectors: requires separate adaptor</li> <li>• Delayed start smoke test</li> </ul>
Suitable detector types:	<ul style="list-style-type: none"> <li>• Optical / photoelectric and ionisation smoke detectors.</li> <li>• Thermal sensors (fixed temperature or rate-of-rise).</li> <li>• Multi-sensors or multi-criteria detectors.</li> <li>• Conventional, addressable, or analogue addressable detectors of any of the above types.</li> <li>• ASD and flat detectors</li> </ul>
Operating temperature range:	Unit: +5°C to 45°C (+41°F to 113°F)  Charger Cradle: +5°C to 40°C (+41°F to 104°F)
Operating humidity range:	0 to 85% RH non-condensing
Storage temperature range:	-10°C to 50°C (+14°F to 122°F)
Storage humidity range:	0 to 90% RH non-condensing (up to +35°C/95°F)
Weight (Including battery, generator & cartridge):	1.25kg with battery Gen and Cartridge 2.39kg boxed with everything
Dimensions H (including handle) x W (widest) x D:	406 x 156 x 150mm
Dimensions H (excluding handle) x W (widest) x D:	302 x 156 150mm
Cup dimensions:	Ø112mm max 38-57mm height (see 2D drawing attached)
Outer carton dimensions H x W x D:	477 x 227 x 177 mm

## 12.3 Support Contact

For help and support, please use contact your local service centre with your product serial number and any error code to hand.

**United Kingdom**  
No Climb Products Ltd.  
Welham Green, AL9 7JE

Tel: +44 (0) 1707 282760  
Email: [detector testers-connect@detektortesters.com](mailto:detector testers-connect@detektortesters.com)  
Web: <https://detektortesters.com/troubleshooting>

**Americas**  
SDi, LLC  
3535 Route 66, Building 6  
Neptune, NJ 07753

Tel: 732-751-9266  
Email: [service@sdifire.com](mailto:service@sdifire.com)  
Web: <https://sdifire.com/support/>



# EU DECLARATION OF CONFORMITY

This declaration of conformity is issued under the sole responsibility of the manufacturer.

**Manufacturer:** Detectortesters (No Climb Products Limited)  
163 Dixons Hill Road, Welham Green, AL9 7JE  
UK Tel: +44(0) 1707 282760



**Represented in the EU by:** shift-consult Hubert Scherzinger  
Hessenweier 9, 79108 Freiburg, DE  
Tel: +49 (0) 7665 91 21 74



---

## Testifire® XTR2 Multi-Stimulus Detector Tester

Consisting of the following models\*:

Testifire-XTR2-XXX Smoke and Heat detector test kit.  
Testifire-XTR2-HEAD-XXX Smoke and Heat detector test head unit. Testifire-BP-XXX Lithium-Ion battery pack  
Testifire-GEN-XXX/Testifire-GEN-1PK-XXX Smoke Generator Testifire-CHAK-XXX Charger Kit  
TES3/TES3-3PACK/TES3-6PACK/TES3-12PACK - XXX Smoke Cartridge

\* These items can be sold separately.

---

The above equipment is in conformity with the following Union harmonized legislations:

1. Radio Equipment Directive 2014/53/EU
2. RoHS Directive 2011/65/EU & 2015/863/EU

The conformity assessment procedure followed is as per ANNEX II of the RED

Conformity to the essential requirements of the legislation(s) have been demonstrated by using the following standards:

---

Art. 3.1(a) Health and Safety	EN 61010-1:2010 EN 61010-1:2010/A1:2019/AC:2019-04 EN 61010-1:2010/A1:2019 EN 50385:2017 EN 62311:2020
-------------------------------	--

---

Art. 3.1(b) Electromagnetic Compatibility	EN 61326-1:2021 EN 301 489-1 V.2.2.3 (2019-11) EN 301 489-3 V.2.1.1 (2019-03) EN 301 489-17 V.31.1 (2017-02) EN 302 291-2 V.1.1.1 (2005-07) EN 302-291-1 V.1.1.1 (2005-07)
---	---

---

Art. 3.2 Spectrum	EN 300 328 V.2.2.2 (2019-07) EN 300 330 V.2.1.1 (2017-02)
-------------------	--

---

RoHS	EN IEC 63000:2018
------	-------------------

---

**This declaration is only valid when:**

- The product is stored and operated under the specified condition.
- Operated by qualified personnel.
- All EMC and safety measures recommended are take care of.

A handwritten signature in black ink, appearing to read "Colin Chapman".

---

Colin Chapman  
VP Engineering  
Signed for and behalf of: Detectortesters (No Climb Products Limited)

Date of issue: 28th November 2023

Place of Signing: Welham Green, Hertfordshire, UK

Validity: Only valid if sent by Detectortesters staff. Certificate valid until July 31, 2025.

Check by contacting [support@detectortesters.com](mailto:support@detectortesters.com)



As our policy is one of continuous improvement, details of products described within this publication are subject to change without notice. All information provided here is believed to be correct at the time of going to press. Every effort has been made to ensure the accuracy of information which is provided in good faith but nothing contained herein is intended to incorporate any representation or warranty, either express or implied or to form the basis of any legal relations between the parties hereto, additional to or in lieu of such as may be applicable to a contract of sale or purchase.