

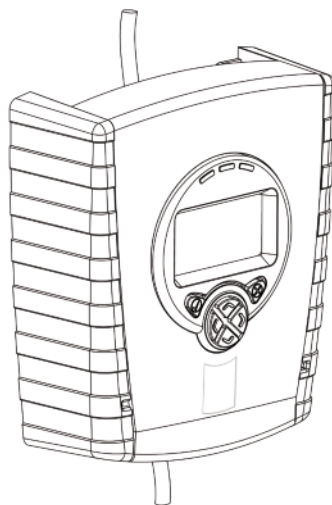

Apollo Intelligent Auto Aligning Beam Detector

User Guide

EN

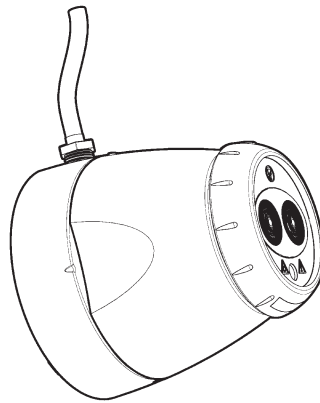

1. General Information

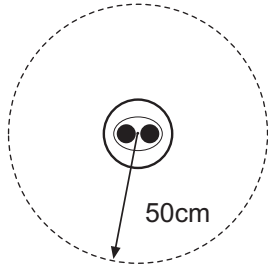

Ensure clear line of sight from Detector to Reflector

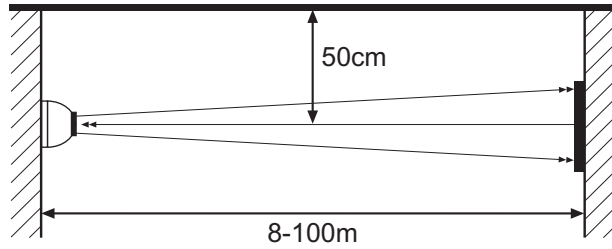

Mount on solid surfaces (structural wall or girder)

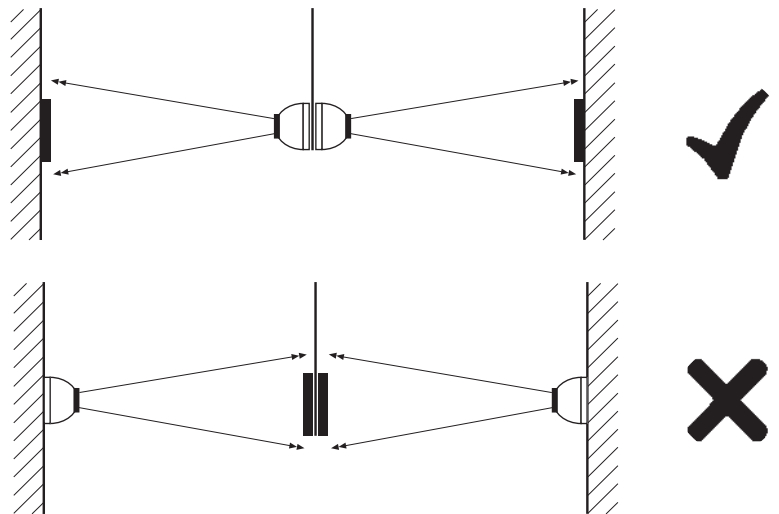
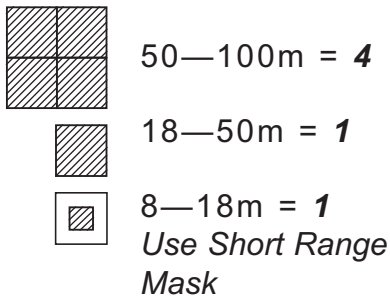

- All installations should comply with local regulations
- For detectors approved to UL268 refer to NFPA72 for installation guidance. In such installations, it is advised that the maximum distance of Detector and Reflector from the ceiling must be 10% of the distance between floor and ceiling
- For installations covering less than 18m, the Short Range Mask must be used
- Position beam as high as possible, but with a minimum distance of 0.5m from Detector and Reflector to ceiling.
- Mount Detector and Reflector directly opposite each other
- Do NOT position Detector where personnel or objects can enter the beam path
- Do NOT position 2 Detectors facing each other
- Detector LED indicator must face downward
- Do NOT install the Detector or Reflector in environments where condensation or icing are likely to occur

2. Fitting the Product

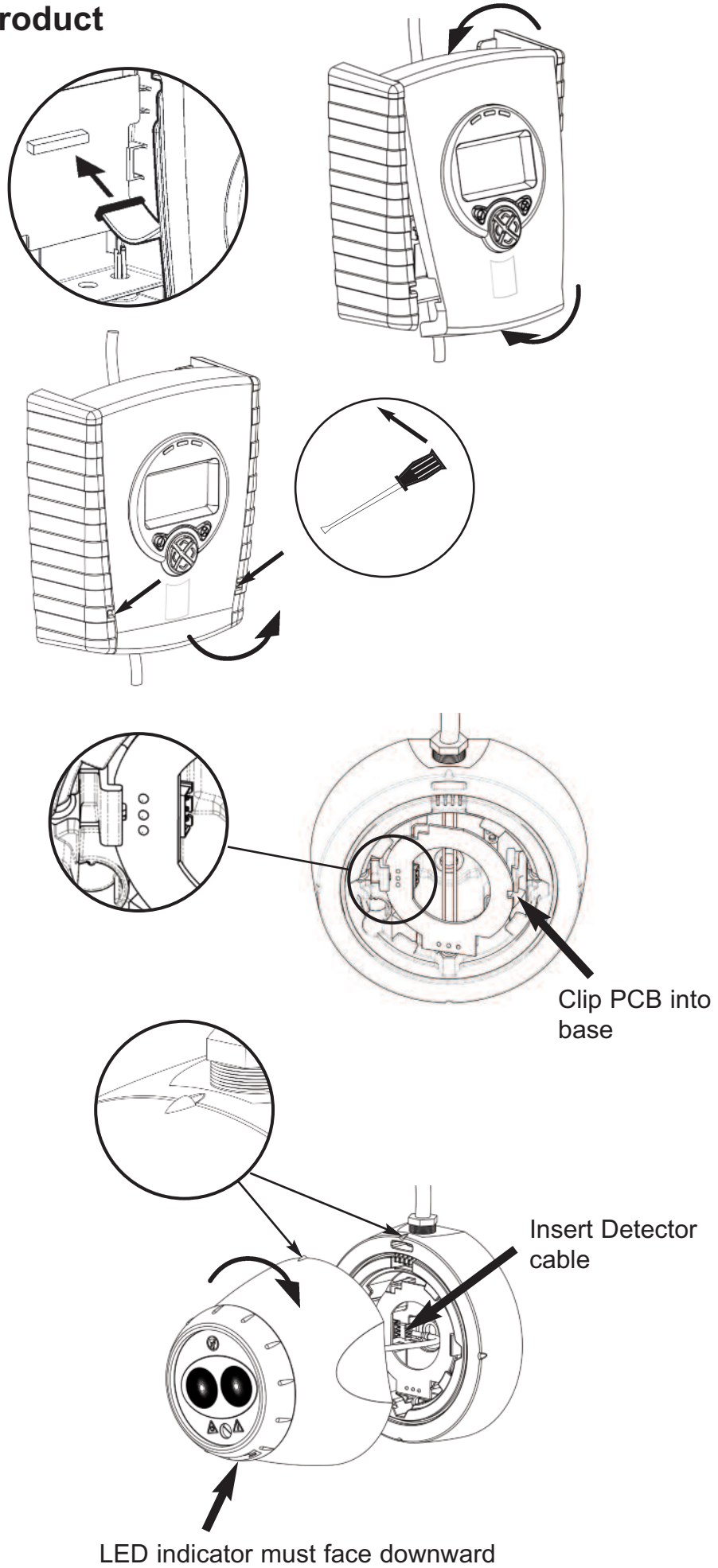

3. Wiring Diagram

It is possible to wire either one or two detectors onto one controller. Refer to section 4. Address Settings for further information on how to select addresses for each detector.

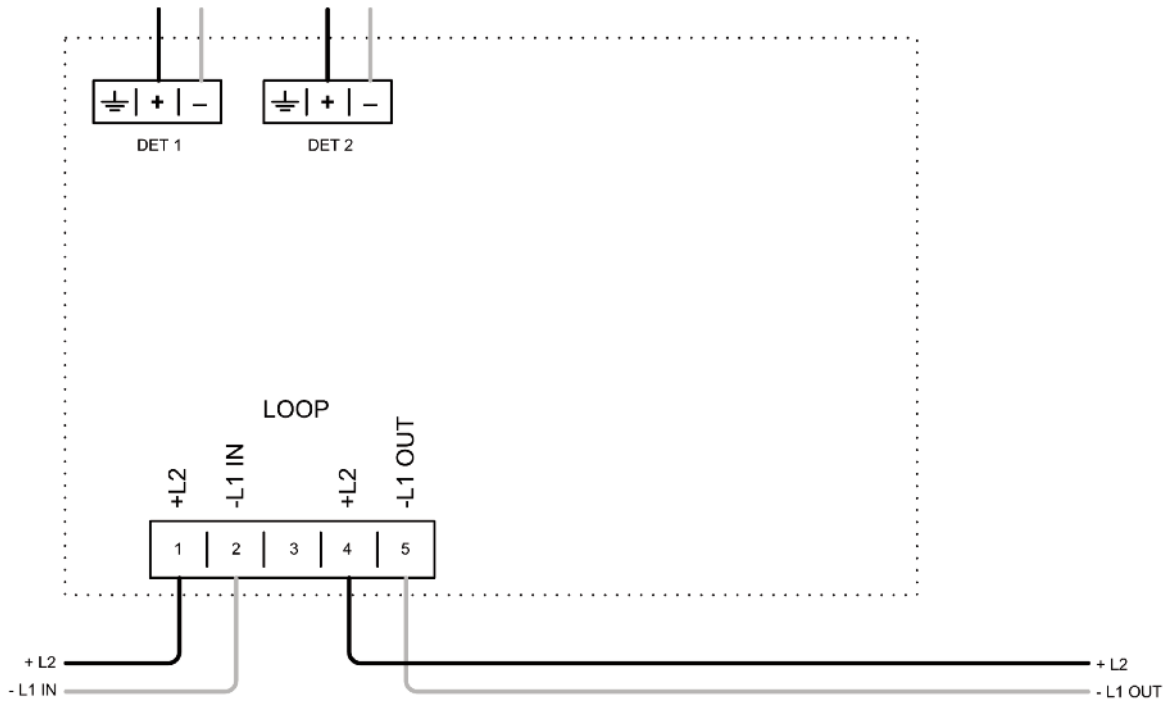

4. Address Settings

Select the required address using address switches 1 to 7 for XP/Discovery and 1 to 8 for Soteria with core enabled panel. The reference table can be viewed below, addresses 127-254 relate only to Soteria. When only one detector is connected it will appear on the address set on the DIP switch. When there are two detectors connected then detector 1 will appear on the selected address and detector two will appear on the selected address +1.

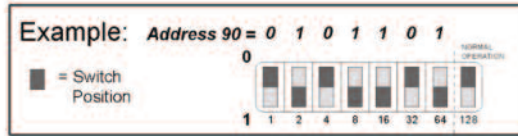

Address	Switch 1	Switch 2	Switch 3	Switch 4	Switch 5	Switch 6	Switch 7
1							
2							
3							
4							
5							
6							
7							
8							
9							
10							
11							
12							
13							
14							
15							
16							
17							
18							
19							
20							
21							
22							
23							
24							
25							
26							
27							
28							
29							
30							
31							
32							
33							
34							
35							
36							
37							
38							
39							
40							
41							
42							
43							
44							
45							
46							
47							
48							
49							
50							
51							
52							
53							
54							
55							
56							
57							
58							
59							
60							
61							
62							
63							
64							
65							
66							
67							
68							
69							
70							
71							
72							
73							
74							
75							
76							
77							
78							
79							
80							
81							
82							
83							
84							
85							
86							
87							
88							
89							
90							
91							
92							
93							
94							
95							
96							
97							
98							
99							
100							
101							
102							
103							
104							
105							
106							
107							
108							
109							
110							
111							
112							
113							
114							
115							
116							
117							
118							
119							
120							
121							
122							
123							
124							
125							

Address

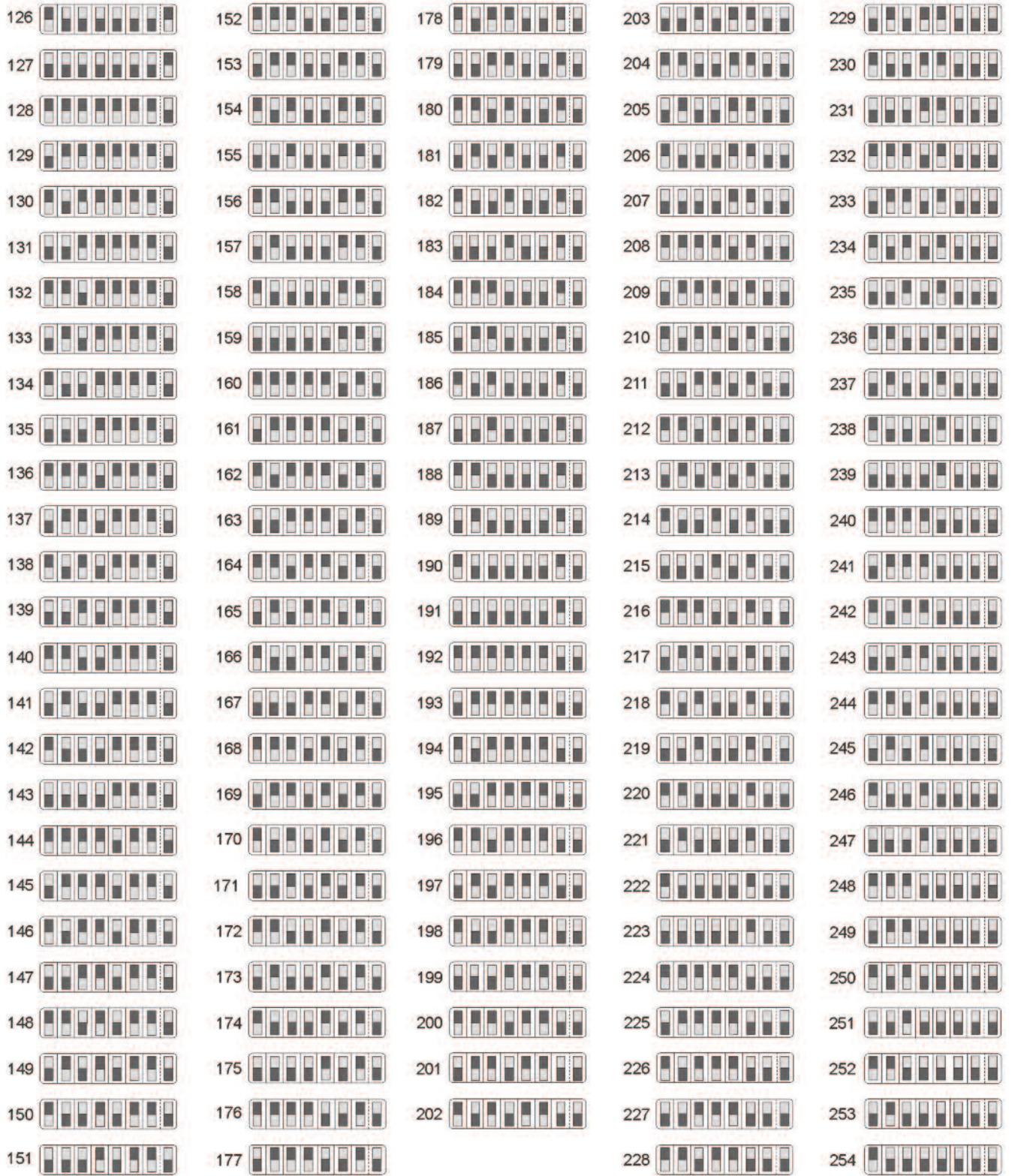

5. Apply power

NOTE: One System Controller can be used to control and monitor up to two Detector heads. The '#' symbol in this guide is used to represent the number of the Detector currently selected (1 or 2).

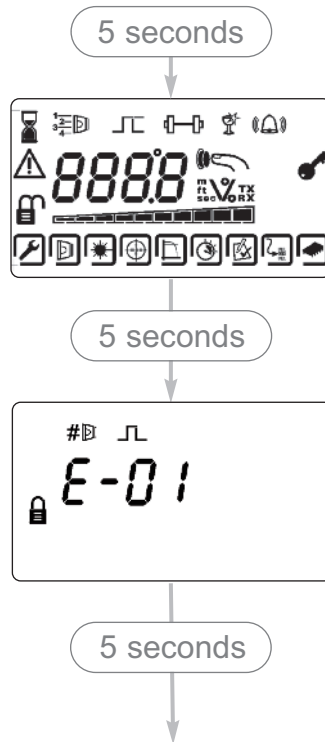

- Commissioned system:
- Detectors have been found but the selected Detector is not aligned:
- Detector is connected but not 'Found' (normal on uncommissioned system):
- Communications fault, or no Detector connected:

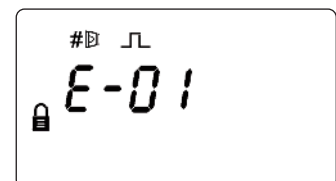
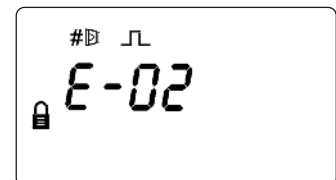
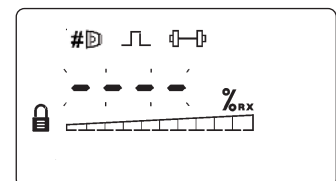
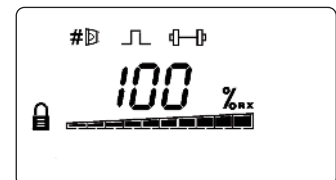

6. Enter Pass Code to Access Engineering Menu

Press ✓ for Pass Code screen:

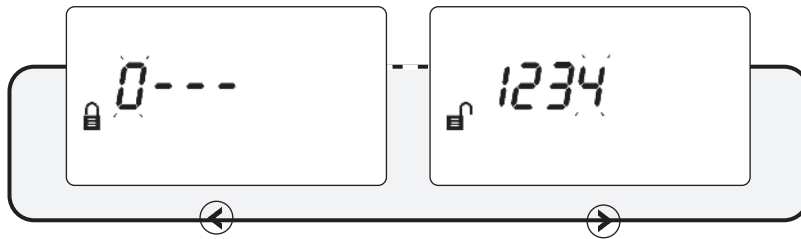

- Default Pass Code: **1 2 3 4**
- ▲ ▼ Change digit
- ◀ ▶ Move between digits
- ✓ Accept
- An incorrect Pass Code will return the display to the Pass Code entry screen
- Three incorrect attempts will lock access for three minutes

7. Find Detectors

- 'Find' is automatically displayed the first time this process is run. 'Find' can also be accessed in the System Controller settings menu. Find must be performed when adding or removing a detector to an already 'Found' system.

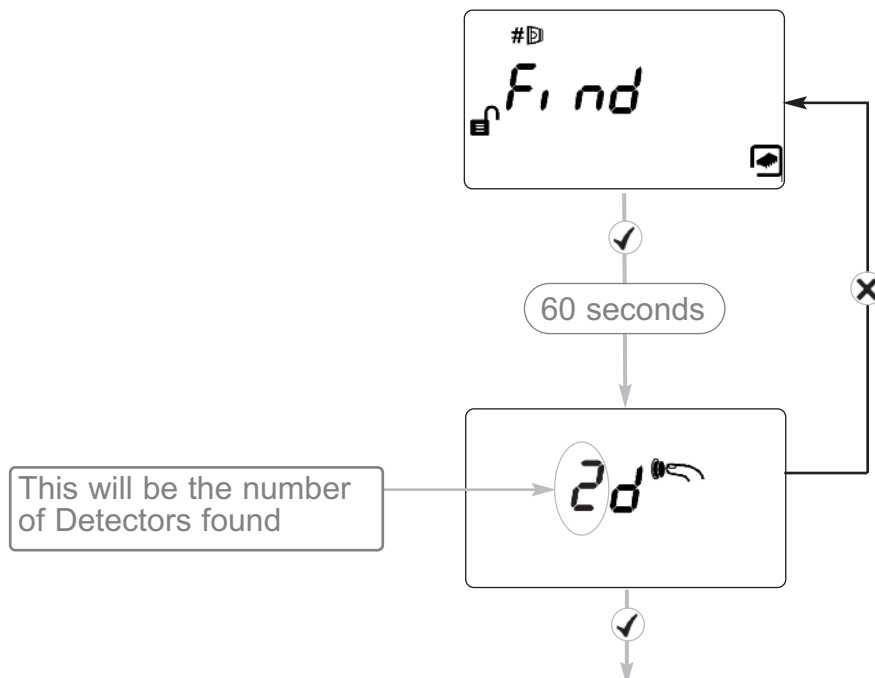

- Press ✓ to enable 'Found' Detectors at any point during 60s countdown
- Any unused Detector channels are switched off
- Press X to re-scan if number is incorrect

8. Select Power Mode

- In 'Hi A' mode (default), during normal operation the system will take 5.5mA if one Detector is connected or 8mA if two Detectors are connected. During Laser targeting, Auto, Hand and Home functions, the system will take 36mA.

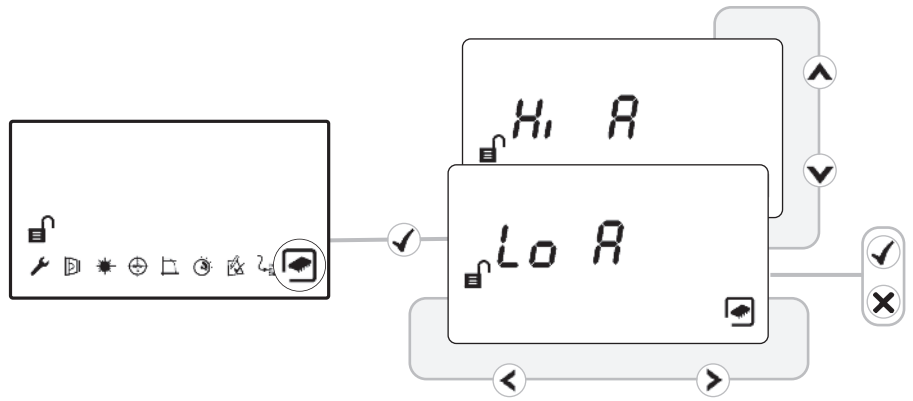

- In 'Lo A' mode (selected via the System Controller settings menu), the system will take 5.5mA or 8mA in ALL modes of operation. The Detector will move more slowly during Align, Laser targeting and Home, so it is recommended to leave the system set to 'Hi A' if the current is available.

Note: When multiple systems are connected to a loop, it is recommended that only one system at a time is used in an alignment mode (HAND, AUTO, LASER, HOME) to ensure that excessive current is not consumed

9. Select Detector

- Select Detector to be accessed
- All Detectors need to be aligned separately
- Steps 9 to 12 explain how to align individual Detectors

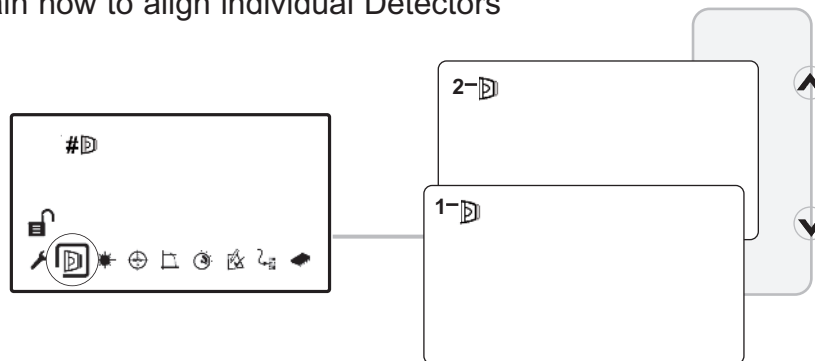

10. Select Distance between Detector and Reflector

- Select 8-50m (default) or 100m (Set for each Detector)

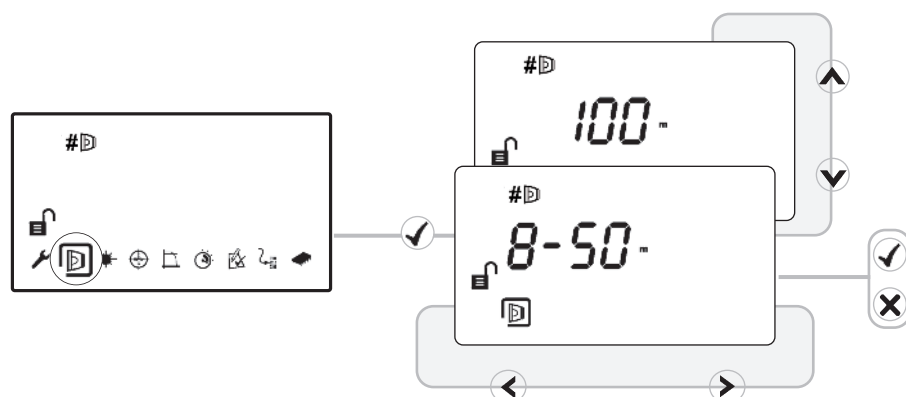

11. LASER Targeting

The system will signal Fault while in this mode

The LASER is used to align the Detector with the Reflector. It is an approximate alignment tool only. After Auto-Align the LASER will not necessarily be pointing on the Reflector

- Use ⬅️ ➡️ ⬆️ ⬇️ to move the LASER as close to the Reflector as possible
- One press of an arrow key results in one movement of the Detector head
- Press ✓ or ✗ to turn off the LASER and return to the Settings menu
- Refer to Additional Detector Information for troubleshooting if LASER is not visible

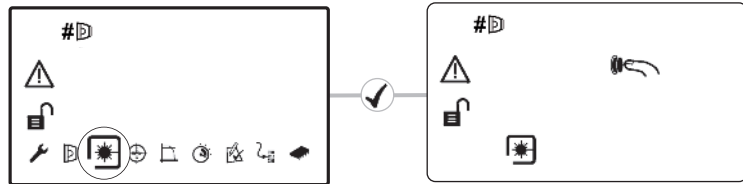

12. 'Auto' Alignment

- Select 'Auto' to automatically align the infrared beam
- Signal Strength will be shown during Alignment
- If the LASER is turned on it will not necessarily be pointing on the Reflector after 'Auto' is run - this is normal
- If 'Auto' ends with an error code 'E- ', refer to troubleshooting

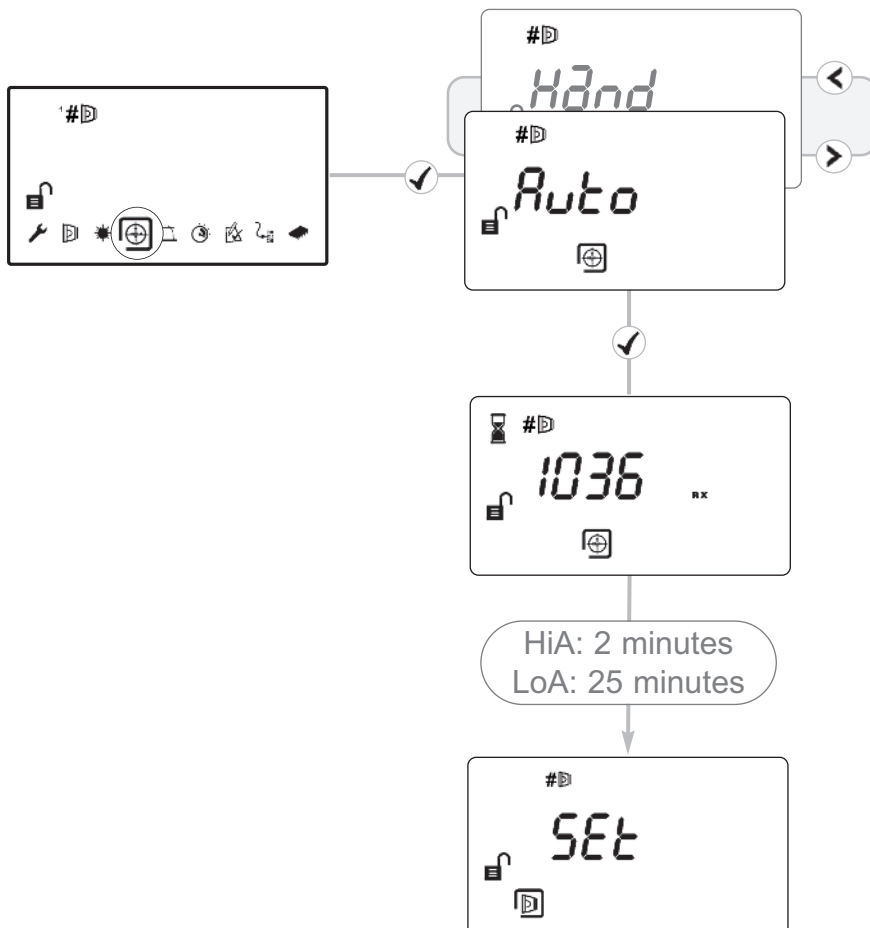

13. 'Set' 0/100 (Calibrate)

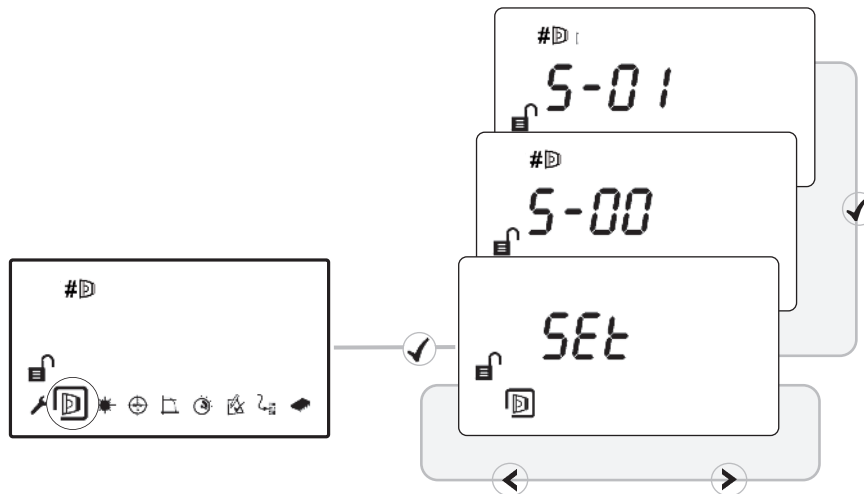

- When 'Set' is displayed press ✓ whilst the Reflector is still uncovered
- When 'S-00' is displayed, cover the Reflector with a non-reflective material and leave covered, then press ✓
- When 'S-01' is displayed, uncover the Reflector and leave uncovered, then press ✓
- Repeat Steps 8 to 12 for any other Detectors found during the 'Find' process ✓

14. System is Aligned

- Green LED on Detector will flash every 10 seconds, and Signal Strength should be between 99% and 101%
- Default values: 35% Fire Threshold, 10 second delay to Fire and Fault, Non-Latching mode

15. Manual Fire and Fault Tests

After installation or cleaning, it is recommended that a manual Fire and Fault test is performed:

Fire Test: Cover the Reflector slowly so that it takes longer than 5 seconds to cover. The System Controller will signal Fire to the Fire Control Panel after the delay to fire has expired (10s default)

Fault Test: Cover the Reflector completely within 2 seconds. The System Controller will signal Fault back to the Fire Control Panel after the delay to fault has expired (10s default)

16. Remote Fire Test

It is possible to perform a Fire Test from the System Controller, to test the wiring to the Fire Control Panel

NOTE: The Remote Fire Test is acceptable for Fire Authority Acceptance and Routine Maintenance per UL268-5

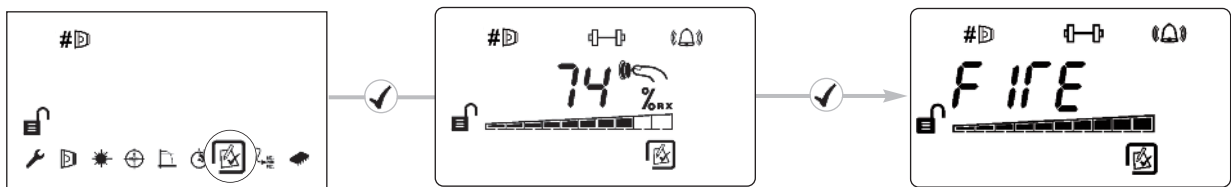

Detector Fire LED Test
Detector will signal Fire,
System Controller will stay
Normal.
Press **X** to exit
without performing the test

Relay/Controller Wiring Test
System Controller signals
'Fire' to Fire Control Panel
Press **✓** or **X** to
exit

17. Fire Threshold

This setting is the threshold at which the Detector will detect a fire
 Default factory setting=35%

(Set for each Detector)

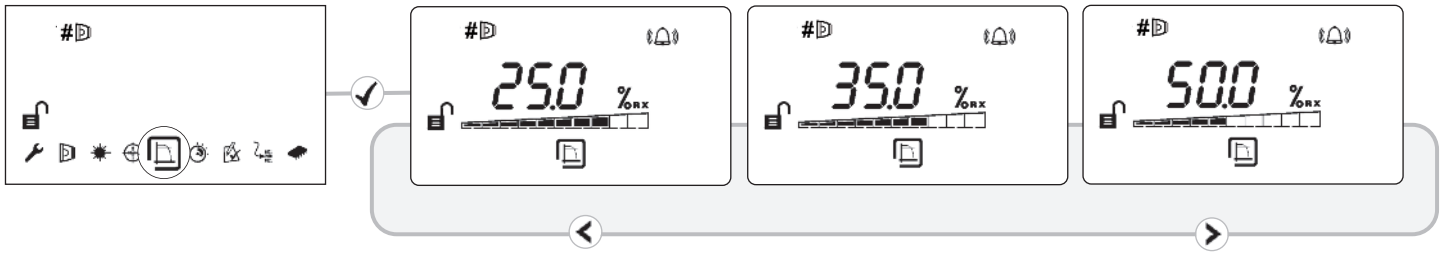

- Sensitivity can be adjusted in 1% steps by pressing up or down keys
- Press ✓ to accept setting

EN Approved Sensitivity Ranges:

Complies with EN54-12 for sensitivity levels between 25% and 35% with a maximum delay to fire of 20 seconds

18. Pre-Alarm Threshold

Analogue value 48 will be transmitted when the signal strength falls below a certain value; this value is based on being 2/3 between 100% and fire threshold. The following table gives examples of this, all other selectable thresholds will have pre-alarm thresholds calculated based on the 2/3 calculation.

Threshold	Signal drop to cause pre-alarm	Signal strength to cause pre-alarm
10%	7%	93%
25%	17%	83%
35%	23%	77%
50%	33%	67%
60%	40%	60%

19. Fire/Fault Delay

These settings are the delays that the System Controller uses before signalling a FIRE or FAULT condition respectively to the Fire Control Panel. Default factory setting=10 seconds

(Set for each Detector)

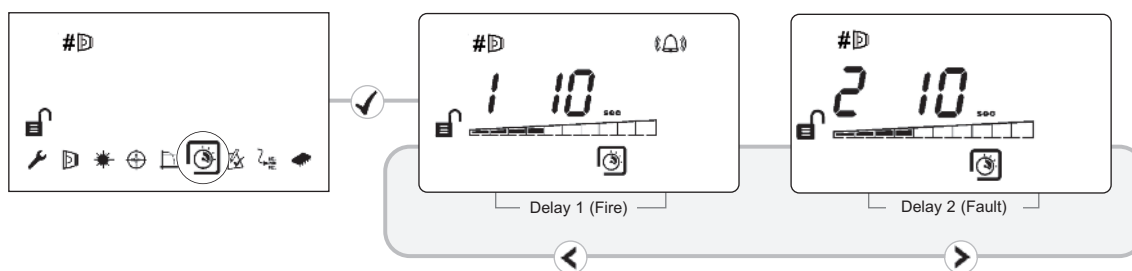

20. Latching/Non-Latching Mode

This detector remains in non-latching mode and therefore this setting is not available

21. Analogue Value and Output Bits

Output Bit	Function	Input Bit	Description
0	Not Used	0	No Action
1	Self Test	1	Initiates the Fire Test within the controller; analogue value 64 will be transmitted if test successful.
2	Alarm LED	2	Illuminate red fire LED on controller and detector.

Analogue Value	Name	Description
0	Microprocessor fault	Internal communications fault within controller
4	General fault	To cover all fault states not covered elsewhere in this table.
5	Signal high fault	Signal >100% or =125% (depending on how quickly signal has changed)
6	AGC limit reached	AGC value has reached its lower (-50) or upper (+205) limit. Also known as 'Drift Fault'
16	Controller powering up	System controller is powering up and has yet to establish communication with detectors
25	Normal	
48	Pre-alarm	Signal strength has fallen below pre-alarm threshold
64	Alarm	Detector has signalled a fire (i.e. signal below fire threshold and delay to fire expired)

22. Cleaning the System

The system will automatically compensate for dust build-up by changing the Compensation Level.

However, it is recommended that the Detector lenses and the Reflector are cleaned periodically with a soft lint-free cloth.

If the Compensation Level for a particular Detector remains above 130 for several days, this indicates that cleaning should take place on that Detector.

The system should be isolated from the Fire Control Panel before cleaning takes place.

After cleaning, verify that the system is operating normally:

If the Signal Strength is between 92% and 108%

- leave the system to compensate back to 100% (this should take no more than 12 hours)

If the Signal Strength is above 108%

- reduce Compensation Level until Signal Strength is 92—108%, and wait for system to compensate back to 100%

If the Signal Strength is below 92%

- perform LASER Targeting, Auto-Align, and Set.

How to change Compensation Level:



23. Event Logger

The System Controller contains a logging function which will store information for the most recent 50 events on each Detector.

To access the event log, press tick on the Event Logger icon when the relevant detector is highlighted:

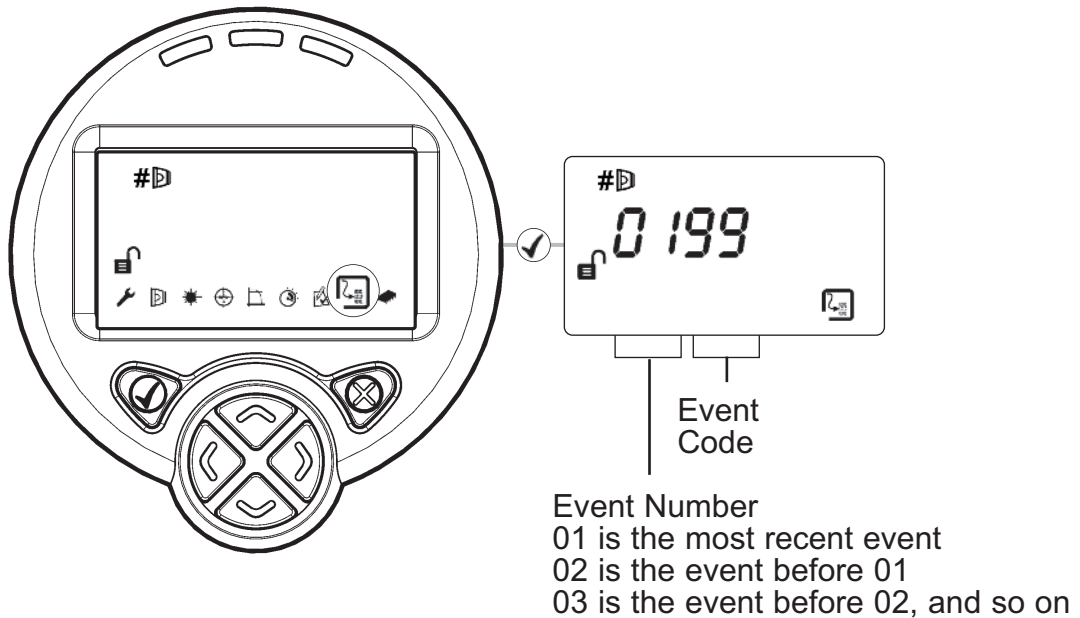

For each Fire or Fault activation, the controller will store:

- The event code – This is the same as the error code (E-__) that would be displayed during the Fault, or one of the following:
 - 99 - Log erased
 - 98 - Power cycle
 - 97 - Fire Detected
 - 96 - Remote Fire Test initiated
 - 95 - AUTO initiated
 - 94 - LASER activated
 - 93 - 'Home' initiated
- The elapsed time since the event occurred
- The duration of the event
- The signal strength when the event occurred (if applicable)
- The AGC value when the event occurred (if applicable)

If there have been power-cycle events on the controller, all timing information will be lost for those events that occurred prior to the most recent of the power-cycles.

To erase and restart the event logger, press and hold 'left' and 'right' keys together when displaying any of the event log entries. Press 'tick' when prompted by 'SurE'.

23. Event Logger (continued)

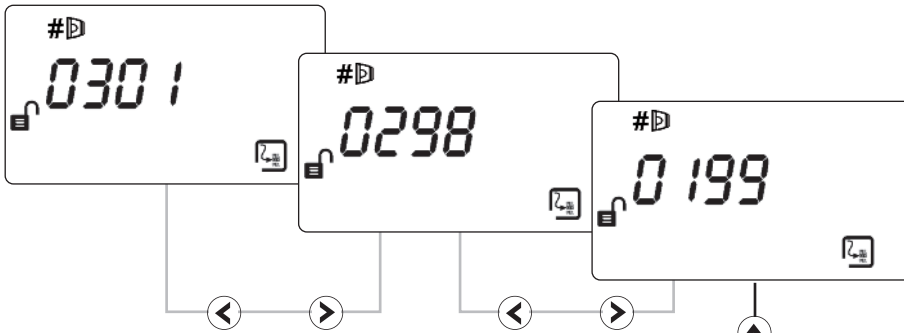

Press left to access older events, and right to access newer events. When the relevant event is selected, press down to access further information about the event.



Time elapsed since event started. '—' will be displayed if the event occurred prior to the most recent power cycle.

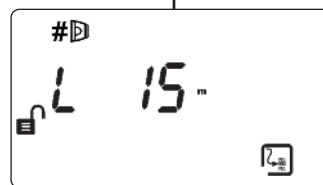

Duration of event. '—' will be displayed if the event is still occurring, or if a power cycle occurred while the event was in progress, or if there is no duration associated with the event type (e.g. power-on)

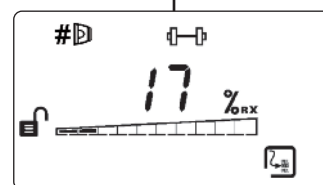

Signal strength when the event occurred. If the signal strength could not be read during the event '—' will be displayed.

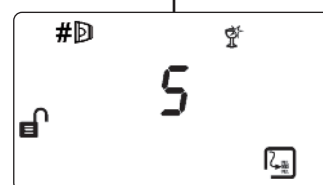

AGC value when the event occurred. If the AGC value could not be read during the event '—' will be displayed.

24. Troubleshooting - LASER not visible

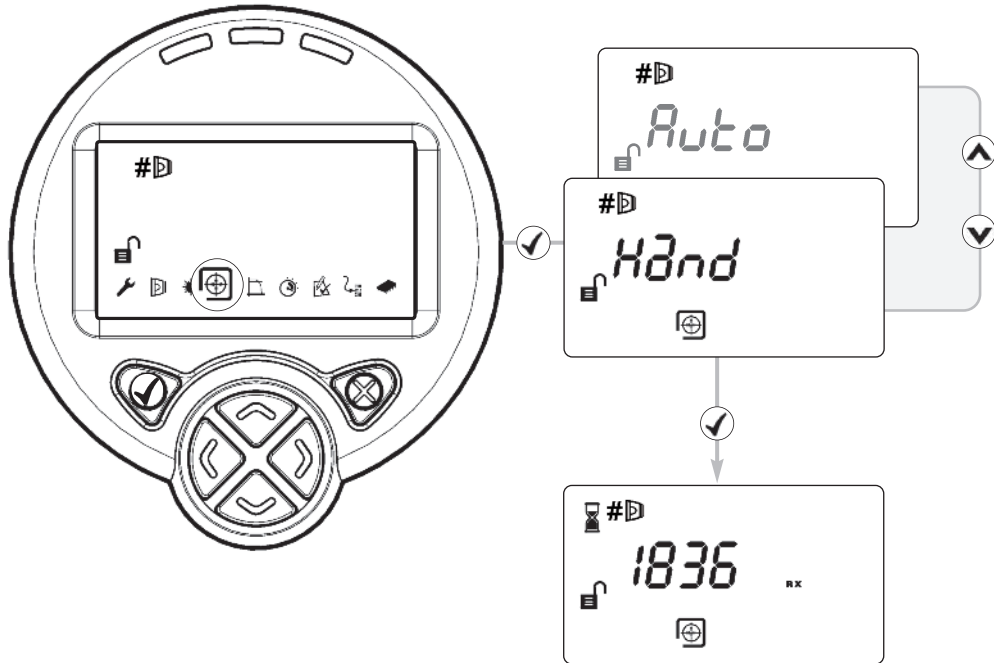

If it is not possible to see the LASER because of the installation environment (for example, if you cannot see the Reflector from the System Controller or there is high ambient light) then use 'Hand' Alignment. This option displays the signal strength value returned by the Detector, and allows the user to move the beam

1. Start 'Auto' Alignment and press **X** after two seconds to exit. (this will maximise infrared power)
2. Select 'Hand' alignment
3. Use **←** **→** **↑** **↓** to steer the beam until the signal strength is above 800. There is no auto-repeat function on any key. To move the motor in any given direction more than once, press the key multiple times
4. Cover the Reflector. If the Signal Strength does not drop by more than half, the beam is not aligned to the Reflector, so repeat Step 3
5. Perform 'Auto' alignment, followed by 'Set'

25. Troubleshooting - HOME

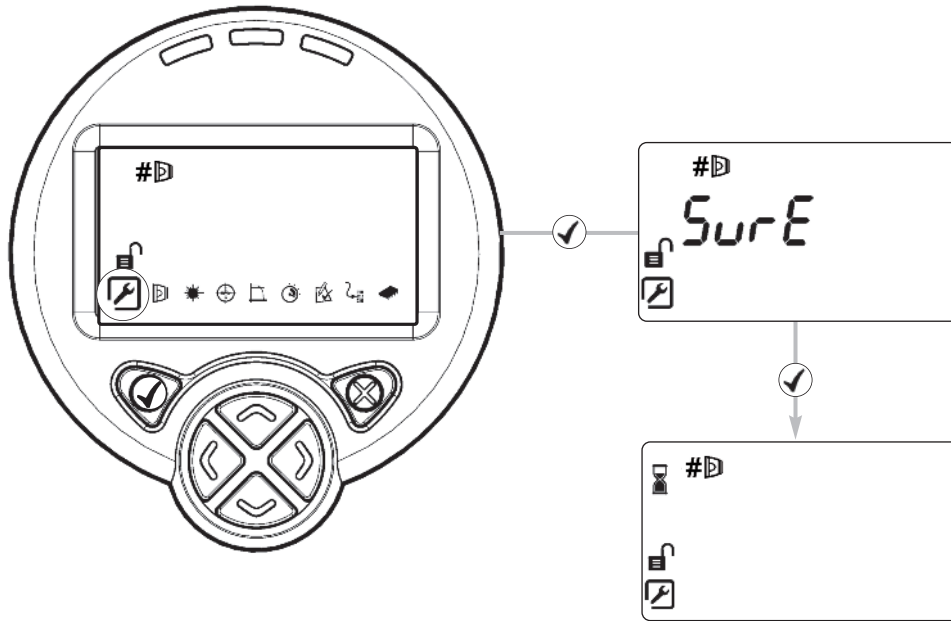

If it is not known where the beam is pointing, use Home Position to automatically steer the infrared beam to approximately the centre of its range of movement.

- Press ✓ or ✗ to exit this function
- This will take up to 3 minutes to complete
- When complete the display will return to the Engineering Menu

26. Troubleshooting - Error Codes

E-00	AIM not recognised	<ul style="list-style-type: none"> Refer to manufacturer for technical assistance 	E-10	Reflector Not Found during Auto-Align	<ul style="list-style-type: none"> Ensure clear line of sight from Detector to Reflector for a radius of 0.5m Ensure correct distance has been selected Ensure correct Reflectors have been used Realign Detector
E-01	Detector Communications Error	<ul style="list-style-type: none"> Check wiring between System Controller and Detector (Voltage to Detector should be 11—13V) 	E-11	Auto-Align Failed	<ul style="list-style-type: none"> Ensure clear line of sight from Detector to Reflector for a radius of 0.5m Ensure correct distance has been selected Ensure correct Reflectors have been used Realign Detector
E-02	Detector is connected but not 'Found'	<ul style="list-style-type: none"> Follow 'Find' process and align if necessary 	E-12	Cannot Zero During 'S-00' in 'Set' Signal did not decrease when 'S-00' selected	<ul style="list-style-type: none"> Ensure Reflector was completely covered with a non-reflective material Re-align Detector using Auto-Align
E-03	Compensation limit reached	<ul style="list-style-type: none"> Clean and realign system 	E-13	No Signal During 'S-01' in 'Set' Signal did not increase when 'S-01' selected	<ul style="list-style-type: none"> Ensure Reflector was uncovered when 'S-01' was selected
E-04	Detector missed too many readings	<ul style="list-style-type: none"> Check voltage to Controller. Check voltage to Detector is >11V 	E-14	'Centre' Stage of Alignment Failed Detector has aligned on something other than the Reflector	<ul style="list-style-type: none"> Ensure clear line of sight from Detector to Reflector for a radius of 0.5m
E-05	Detector is not aligned	<ul style="list-style-type: none"> Follow alignment procedure 	E-21	Power too low fault	<ul style="list-style-type: none"> Check power supply to Controller
E-06	Rapid Obscuration Fault	<ul style="list-style-type: none"> Ensure clear line of sight from Detector to Reflector 	E-24	Detector not compatible	<ul style="list-style-type: none"> Refer to manufacturer for technical assistance
E-07	Signal Too High Fault	<ul style="list-style-type: none"> Ensure clear line of sight from Detector to Reflector Ensure there is no strong light on Detector 	E-26	Internal controller fault	<ul style="list-style-type: none"> Refer to manufacturer for technical assistance
E-08	Compensation Level Not Zero during 'SET'	<ul style="list-style-type: none"> Re-align Detector using Auto-Align 	E-30	Isolator Active	<ul style="list-style-type: none"> Isolator within the controller has activated. Amber fault LEDs will also flash
E-09	Signal Strength Out of Range when 'SET' selected	<ul style="list-style-type: none"> Ensure Reflector uncovered when 'SET' selected Ensure clear line of sight from Detector to Reflector for a radius of 0.5m Ensure correct distance has been selected Ensure correct Reflectors have been used Realign Detector 			

27. Technical Specifications

Parameter	Value
Operating Voltage	17—35Vdc + comms pulses
Operating Current – Normal Operation (including fire or fault activated)	7.5mA - 1 Detector 10mA - 2 Detectors
Operating Current – Alignment modes - HiA Alignment modes - LoA	36mA 7.5mA / 10mA
Fire Threshold Range	0.45—3.98 dB 10—60%
Delay to Fire	2—30 s
Delay to Fault	2—30 s
Operating Distance between Detector and Reflector	8—100 m
Maximum angular misalignment of Detector	± 0.3 Deg
Maximum angular misalignment of Reflector	± 5 Deg
Maximum angular movement of Detector head	± 3.5 Deg
Optical wavelength	850 nm
Rapid Obscuration Fault threshold	87%
Operating Temperature (UL Approved)	0—+37.8 Deg C
Operating Temperature (EN54-12 Approved)	-10—+55 Deg C
Operating Temperature (FM Approved)	-20—+55 Deg C
Storage temperature	-40—+85 Deg C
Relative Humidity (non condensing)	93%
IP Rating	IP54
Maximum Cable Length (Controller to Detector)	100 m
Cable Gauge	24—14 AWG 0.5—1.6 mm
Housing Flammability rating	UL94 V0

This detector incorporates a Soteria isolator and follows the specification as listed in Apollo publication PP2090, except for minimum 'on' resistance (Z_c) which is 0.2Ω .

Dimensions	Width, mm (in)	Height, mm (in)	Depth, mm (in)	Weight, kg (lb)
System Controller, including base	202 (8.0)	230 (9.1)	81 (3.2)	1.0 (2.2)
Detector, including 'easy fit' base	135 (5.3)	135 (5.3)	135 (5.3)	0.5 (1.1)
Reflector (Single)	100 (3.9)	100 (3.9)	10 (0.4)	0.1 (0.2)

27. Equipment Disposal



Products marked with this symbol cannot be disposed of as unsorted municipal waste in the European Union. For proper recycling, return this product to your local supplier upon the purchase of equivalent new equipment, or dispose of it at designated collection points. For more information see: www.recyclethis.info.



